

## Overview

### HP ProDesk 400 G6 Desktop Mini PC



1. Type-C® SuperSpeed USB 10Gbps signaling rate port (charge support up to 5V/3A)
2. Type-A SuperSpeed USB 10Gbps signaling rate port
3. Type-A SuperSpeed USB 5Gbps signaling rate port (charge support up to 5V/1.5A)
4. Combo Audio Jack with CTIA and OMTP headset support
5. Dual-state power button
6. Hard drive activity light

#### **Not Shown**

(2) M.2 (1 as M.2 2230 socket for WLAN/BT and 1 as M.2 2280 socket for storage)

(1) 2.5" internal storage drive bay

## Overview

### HP ProDesk 400 G6 Desktop Mini PC

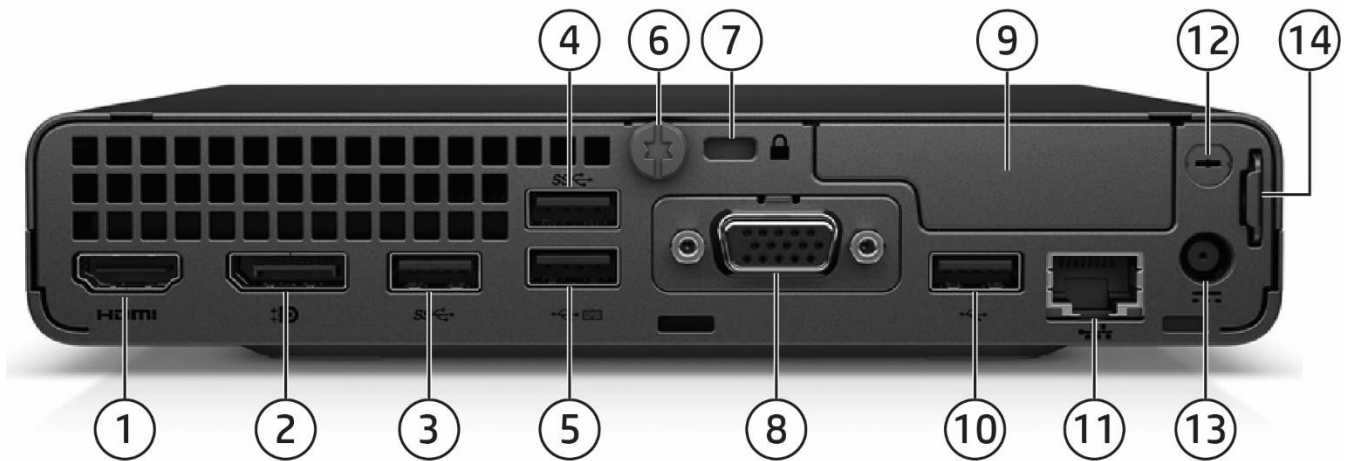

1. HDMI 1.4
2. Dual-Mode DisplayPort™ 1.4 (DP++)
3. Type-A SuperSpeed USB 5Gbps signaling rate port
4. Type-A SuperSpeed USB 5Gbps signaling rate port (Supporting wake from S4/S5 with keyboard/mouse connected and enabled in BIOS)
5. Type-A Hi-Speed USB 480Mbps signaling rate or SuperSpeed USB 10Gbps signaling rate port<sup>1</sup> (Supporting wake from S4/S5 with keyboard/mouse connected and enabled in BIOS)
6. Cover release thumbscrew
7. Standard cable lock slot (10 mm)
8. Flex Port 1, choice of:
  - DisplayPort™
  - HDMI
  - Type-C® SuperSpeed USB 10Gbps signaling rate port w/ DisplayPort™ Alt Mode and power intake via USB Type-C® Power Delivery up to 100W
  - VGA
  - Serial<sup>2</sup>
9. Flex Port 2<sup>3</sup>, choice of:
  - 2x Type-A Hi-Speed USB 480Mbps signaling rate port
  - Serial
10. Type-A Hi-Speed USB 480Mbps signaling rate or SuperSpeed USB 10Gbps signaling rate port<sup>1</sup>
11. RJ45 network connector
12. External WLAN antenna opening<sup>3</sup>
13. Power connector
14. Retractable Padlock loop

1. Upgradeable to SuperSpeed USB 10Gbps signaling rate port if configured with additional digital video port via Flex Port 1 and/or Intel® vPro™.

2. Sold separately or as an optional feature.

3. Must be configured at time of purchase.

## Overview

### HP ProDesk 400 G7 Small Form Factor PC



1. Slim optical drive (optional)
2. SD card 4.0 reader (optional)
3. (2) Type-A SuperSpeed USB 10Gbps signaling rate port
4. (2) Type-A Hi-Speed USB 480Mbps signaling rate port
5. Combo Audio Jack with CTIA and OMTP headset support
6. Dual-state power button
7. Hard drive activity light

#### **Not Shown**

- (1) PCI Express x16
- (1) PCI Express x1
- (2) M.2 (1 as M.2 2230 socket for WLAN/BT and 1 as M.2 2280 socket for storage)

## Overview

### HP ProDesk 400 G7 Small Form Factor PC

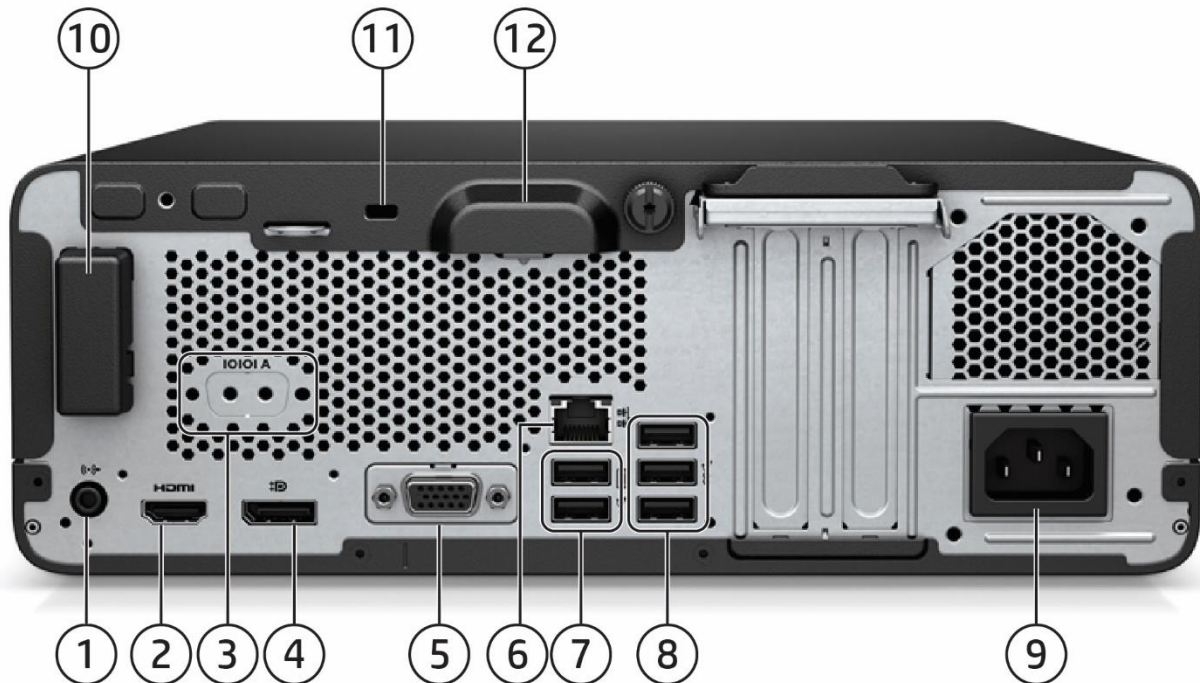

1. Audio-out connector
2. HDMI 1.4
3. Serial Port (Optional)
4. Dual-Mode DisplayPort™ 1.4 (DP++)
5. Flex Port, choice of:
  - DisplayPort™1.4
  - HDMI 2.0
  - VGA
  - Serial
  - Dual Type-A SuperSpeed USB 5Gbps signaling rate
  - Type-C® SuperSpeed USB 10Gbps signaling rate with DisplayPort™ Alt mode
6. RJ45 network connector
7. (2) Type-A Hi-Speed USB 480Mbps signaling rate port (Supporting wake from S4/S5 with keyboard/mouse connected and enabled in BIOS)
8. (3) Type-A SuperSpeed USB 5Gbps signaling rate port
9. Power cord connector
10. Internal WLAN antenna cover (optional)
11. Standard cable lock slot
12. Integrated accessory cable lock

#### **Not Shown**

##### **Port**

Optional PS/2 (2 ports) & serial port card<sup>1</sup> (connected with mainboard via flyer cable)

Optional parallel port<sup>1</sup>

Optional 4 serial port PCIe card<sup>1</sup>

##### **Bay**

(1) 9.5mm internal optical drive bay

(1) 3.5" internal storage drive bay or (2) 2.5" internal storage drive bays<sup>2</sup>

1. Each of the legacy options will occupy one rear slot.

2. SFF can be configured with either (1) 3.5" or (2) 2.5" internal storage drive (2.5-inch drive needs adapter that can only be purchased when configuring the PC from factory with a 2.5" drive)

## HP ProDesk 400 G7 Microtower PC

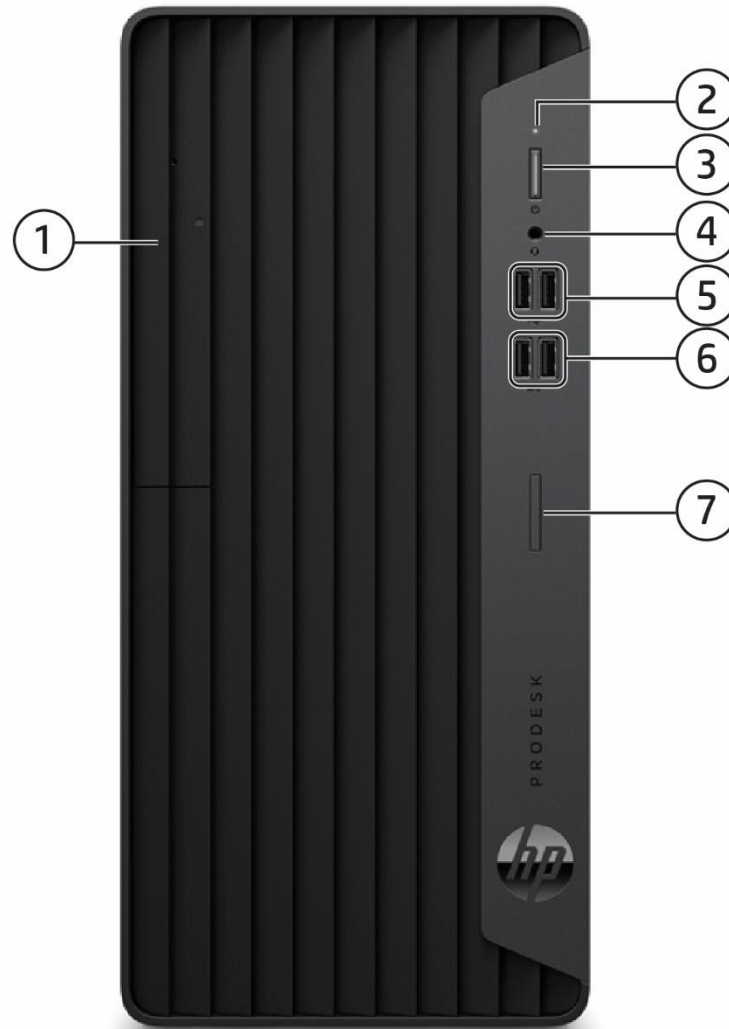

- |                                  |   |
|----------------------------------|---|
| 1. Slim optical drive (optional) | 4. Combo Audio Jack with CTIA and OMPT headset support  |
| 2. Hard drive activity light     | 5. (2) Type-A Hi-Speed USB 480Mbps signaling rate port  |
| 3. Dual-state power button       | 6. (2) Type-A SuperSpeed USB 10Gbps signaling rate port |
|                                  | 7. SD card 4.0 reader (optional)                        |

### **Not Shown**

- (1) PCI Express x16
- (2) PCI Express x1
- (2) M.2 (1 as M.2 2230 socket for WLAN/BT and 1 as M.2 2280 socket for storage)

## Overview

### HP ProDesk 400 G7 Microtower PC

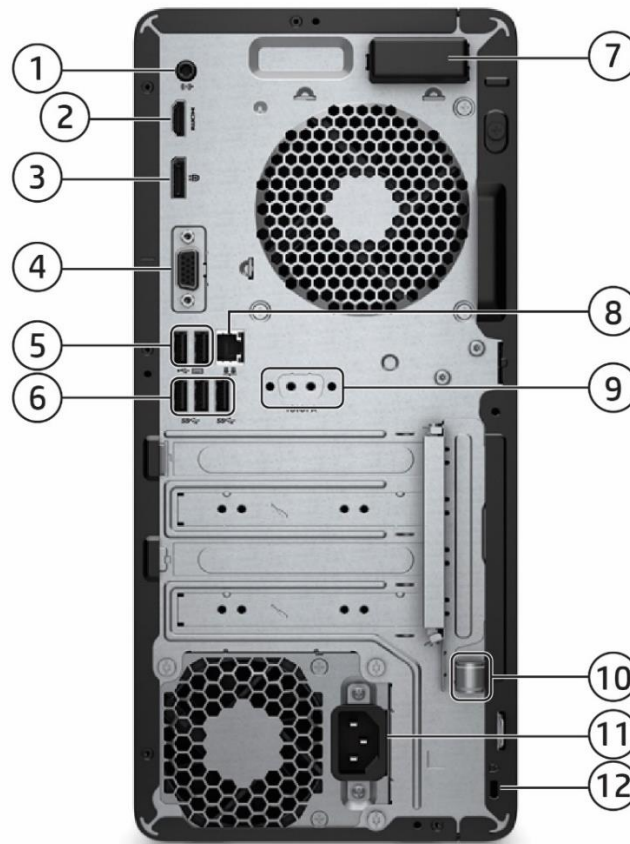

- |  |  |
|--|--|
| <ol style="list-style-type: none"> <li>1. Audio-out connector</li> <li>2. HDMI 1.4</li> <li>3. Dual-Mode DisplayPort™ 1.4 (DP++)</li> <li>4. Flex Port, choice of: <ul style="list-style-type: none"> <li>• DisplayPort™ 1.4</li> <li>• HDMI 2.0</li> <li>• VGA</li> <li>• Serial</li> </ul> </li> <li>5. (2) Type-A Hi-Speed USB 480Mbps signaling rate (Supporting wake from S4/S5 with keyboard/mouse connected and enabled in BIOS)</li> <li>6. (3) Type-A SuperSpeed USB 5Gbps signaling rate port</li> <li>7. Internal WLAN antenna cover (optional)</li> <li>8. RJ45 network connector</li> <li>9. Serial port (optional)</li> <li>10. Integrated accessory cable lock</li> <li>11. Power cord connector</li> <li>12. Standard cable lock slot</li> </ol> | <ol style="list-style-type: none"> <li>5. (2) Type-A Hi-Speed USB 480Mbps signaling rate (Supporting wake from S4/S5 with keyboard/mouse connected and enabled in BIOS)</li> <li>6. (3) Type-A SuperSpeed USB 5Gbps signaling rate port</li> <li>7. Internal WLAN antenna cover (optional)</li> <li>8. RJ45 network connector</li> <li>9. Serial port (optional)</li> <li>10. Integrated accessory cable lock</li> <li>11. Power cord connector</li> <li>12. Standard cable lock slot</li> </ol> |
|--|--|

#### **Not Shown**

##### **Port**

Optional PS/2 (2 ports) & serial port card (connected with mainboard via flyer cable)<sup>1</sup>

Optional parallel port<sup>1</sup>

Optional 4 Serial Port PCIe Card<sup>1</sup>

##### **Bay**

(1) 9.5mm internal optical drive bay

(1) 3.5" internal storage drive bay or (1) 2.5" internal storage drive bay

(1) 3.5" internal storage drive bay

(1) 2.5" internal storage drive bay

1. Each of the legacy options will occupy one rear slot

## HP ProDesk 480 G7 PCI Microtower PC

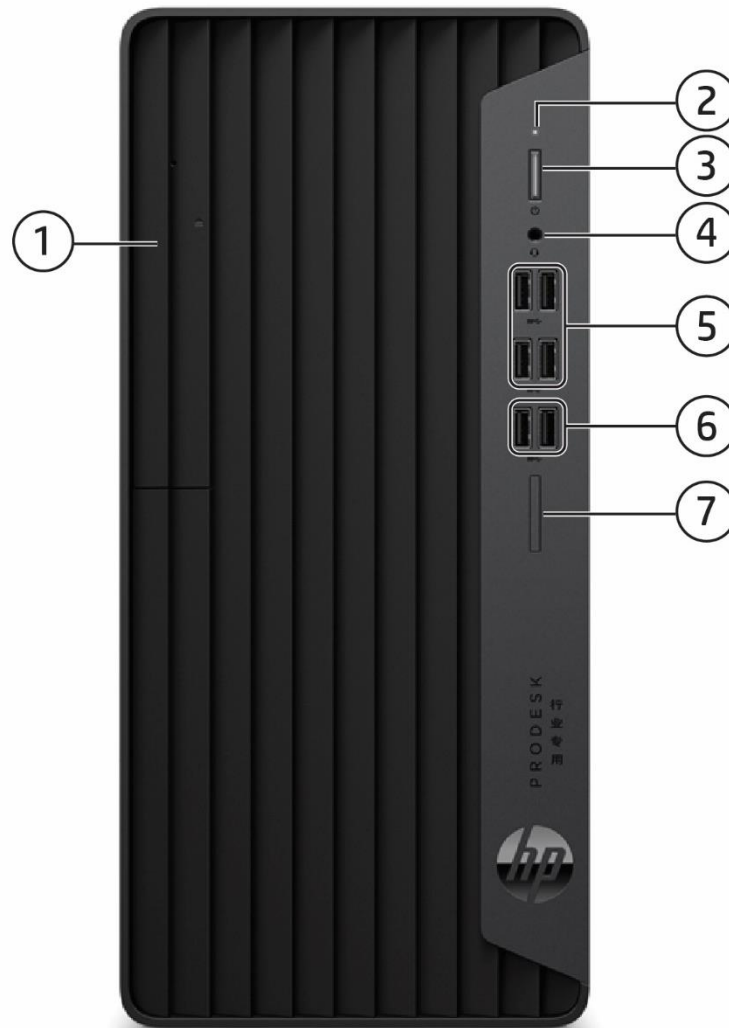

- |  |   |
|--|---|
| <ul style="list-style-type: none"> <li>1. Slim optical drive (optional)</li> <li>2. Hard drive activity light</li> <li>3. Dual-state power button</li> </ul> | <ul style="list-style-type: none"> <li>4. Combo Audio Jack with CTIA and OMTP headset support</li> <li>5. (4) Type-A SuperSpeed USB 5Gbps signaling rate port</li> <li>6. (2) Type-A SuperSpeed USB 10Gbps signaling rate port</li> <li>7. SD card 4.0 reader (optional)</li> </ul> |
|--|---|

**Not Shown**

- (1) PCI Express x16
- (1) PCI Express x1
- (1) PCI x1
- (2) M.2 (1 as M.2 2230 socket for WLAN/BT and 1 as M.2 2280 socket for storage)

## Overview

### HP ProDesk 480 G7 PCI Microtower PC

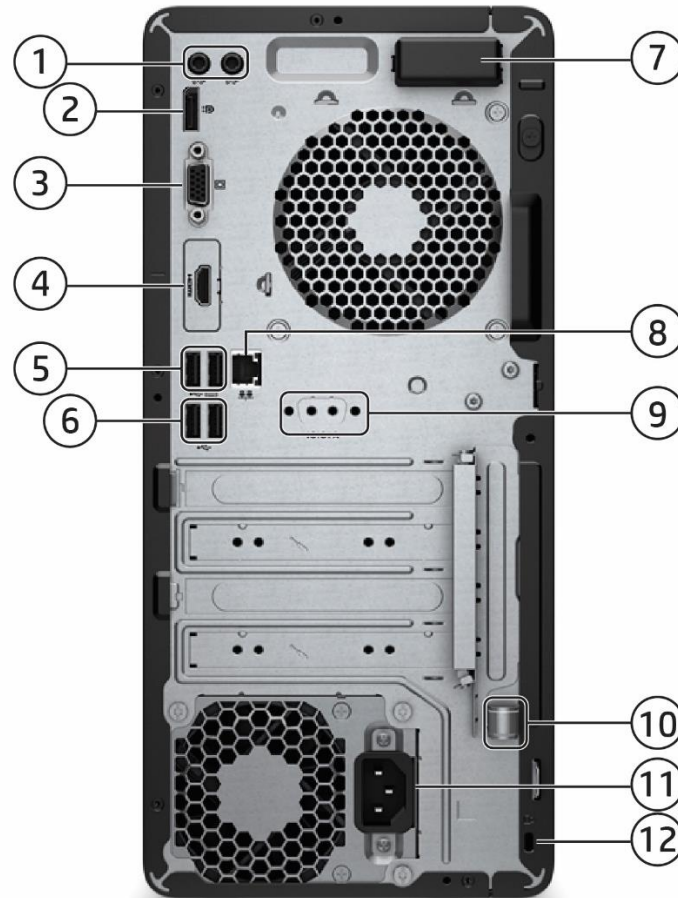

- |  |  |
|--|--|
| <ol style="list-style-type: none"> <li>1. Audio-in/out connector</li> <li>2. Dual-Mode DisplayPort™ 1.4 (DP++)</li> <li>3. VGA port</li> <li>4. Flex Port, choice of: <ul style="list-style-type: none"> <li>• DisplayPort™ 1.4</li> <li>• HDMI 2.0</li> <li>• VGA</li> <li>• Serial</li> </ul> </li> <li>5. (2) Type-A Hi-Speed USB 480Mbps signaling rate port (Supporting wake from S4/S5 with keyboard/mouse connected and enabled in BIOS)</li> </ol> | <ol style="list-style-type: none"> <li>6. (2) Type-A Hi-Speed USB 480Mbps signaling rate port</li> <li>7. Internal WLAN antenna cover (optional)</li> <li>8. RJ45 network connector</li> <li>9. Serial port (optional)</li> <li>10. Integrated accessory cable lock</li> <li>11. Power cord connector</li> <li>12. Standard cable lock slot</li> </ol> |
|--|--|

#### **Not Shown**

##### **Port**

Optional PS/2 (2 ports) & serial port card (connected with mainboard via flyer cable)<sup>1</sup>

Optional parallel port<sup>1</sup>

Optional 4 Serial Port PCIe Card<sup>1</sup>

##### **Bay**

(1) 9.5mm internal optical drive bay

(1) 3.5" internal storage drive bay or (1) 2.5" internal storage drive bay

(1) 2.5" internal storage drive bay

(1) 3.5" internal storage drive bay

1. Each of the legacy options will occupy one rear slot



## Overview

### HP ProOne 400 G6 24 All-in-One PC (Touch & Non-Touch)<sup>1</sup>



- |  |  |
|--|--|
| 1. Pull-up webcam (optional)                           | 6. Hard drive activity light   |
| 2. Combo Audio Jack with CTIA and OMTP headset support | 7. Power button  |
| 3. Speakers (optional)                                 | 8. Type-A SuperSpeed USB 10Gbps signaling rate port (charge support up to 5V/1.5A) |
| 4. SD media card reader (optional)                     | 9. Type-C® SuperSpeed USB 10Gbps signaling rate port (charge support up to 5V/3A)  |
| 5. On-screen display (OSD) buttons                     |  |

HD webcam (optional)

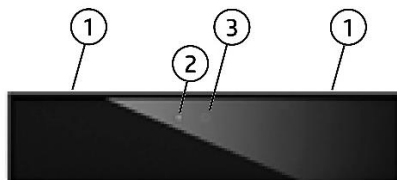

5MP webcam (optional)

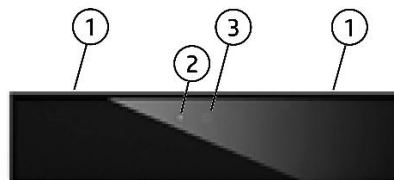

5MP webcam with Infrared (IR) sensors (optional)

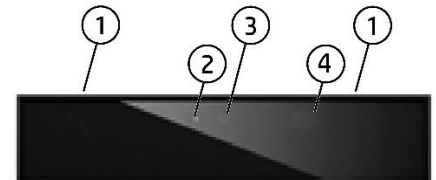

1. Dual microphones
2. Webcam light
3. HD webcam

1. Dual microphones
2. Webcam light
3. 5MP webcam

1. Dual microphones
2. Webcam light
3. IR/5MP webcam
4. IR light

## Overview

### HP ProOne 400 G6 24 All-in-One PC (Touch & Non-Touch)<sup>1</sup>

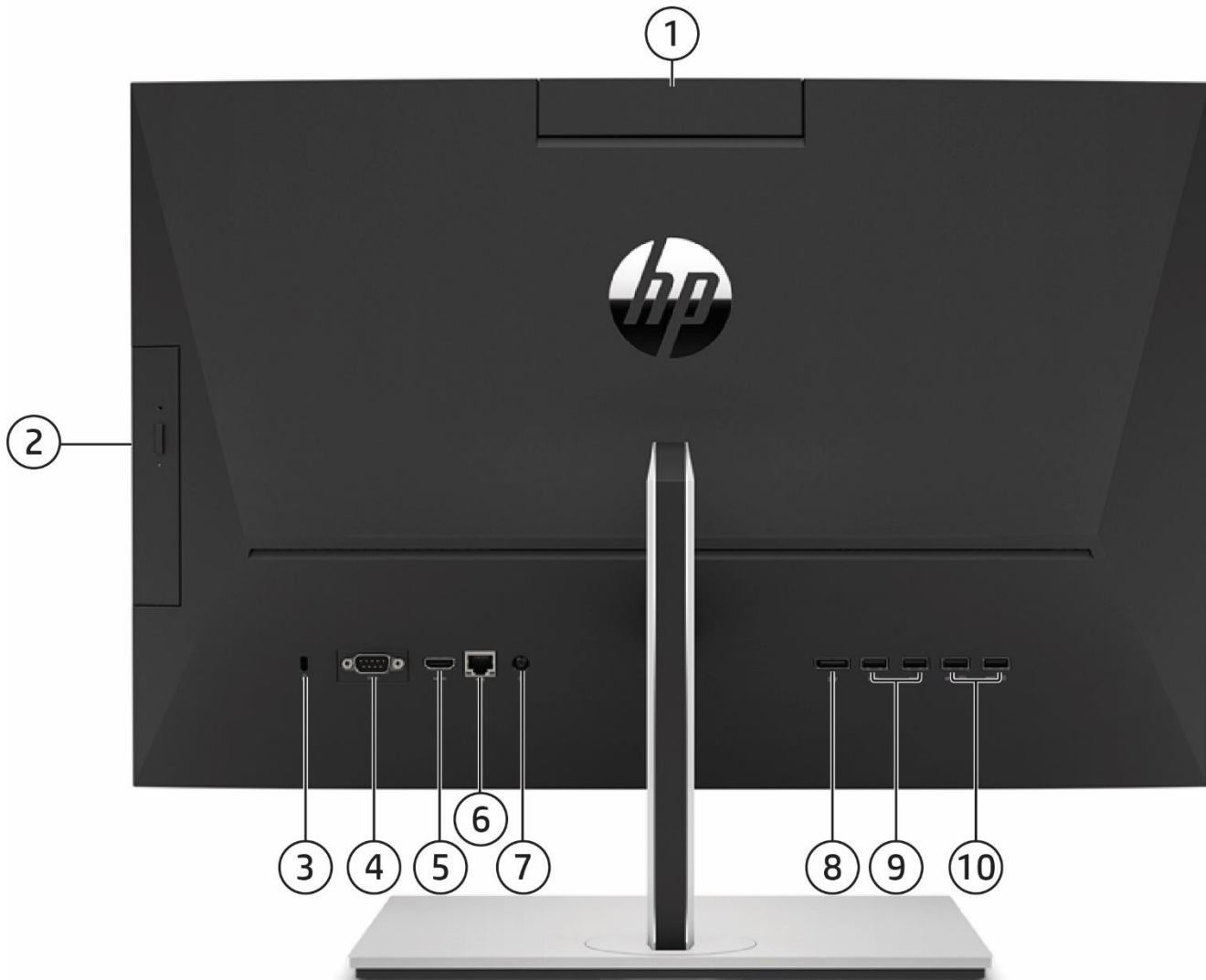

1. Pull-up webcam (optional)
2. Optical disc drive (optional)
3. Standard cable lock slot
4. Flex Port, choice of:
  - DisplayPort™
  - Serial
  - HDMI
5. HDMI-in
6. RJ45 network connector
7. Power connector
8. Dual-Mode DisplayPort™ 1.4 (DP++)
9. (2) Type-A SuperSpeed USB 5Gbps signaling rate port
10. (2) Type-A SuperSpeed USB 5Gbps signaling rate port (Supporting wake in from S4/S5 with keyboard/mouse connected and enabled BIOS)

1. Availability may vary by country

## Overview

### HP ProOne 400 G6 20 All-in-One PC (Non-Touch)<sup>1</sup>



1. Dual microphones (optional)
2. Webcam privacy shutter (optional)
3. HD webcam (optional)
4. Webcam light
5. Combo Audio Jack with CTIA and OMTP headset support
6. Speakers (optional)

7. SD media card reader (optional)
8. On-screen display (OSD) buttons
9. Hard drive activity light
10. Power button
11. Type-A SuperSpeed USB 10Gbps signaling rate port (charge support up to 5V/1.5A)
12. Type-C® SuperSpeed USB 10Gbps signaling rate port (charge support up to 5V/3A)

## Overview

### HP ProOne 400 G6 20 All-in-One PC (Non-Touch)<sup>1</sup>



1. Optical disc drive (optional)
2. Standard cable lock slot
3. Flex Port, choice of:
  - DisplayPort™
  - Serial
  - HDMI
4. HDMI-in
5. RJ45 network connector

6. Power connector
7. Dual-Mode DisplayPort™ 1.4 (DP++)
8. (2) Type-A SuperSpeed USB 5Gbps signaling rate port
9. (2) Type-A SuperSpeed USB 5Gbps signaling rate port (Supporting wake from S4/S5 with keyboard/mouse connected and enabled in BIOS)

1. Availability may vary by country

Standard Features and Configurable Components (availability may vary by country)

## AT A GLANCE

- Choice of four form factors: Microtower, Small Form Factor, Desktop Mini, and All-in-One
- HP developed and engineered UEFI V2.7 BIOS supporting security, manageability and software image stability
- Latest commercial class Intel® 400 Series chipsets supporting latest Intel® 10th Generation Core™ processors<sup>1</sup>, featuring integrated Intel® UHD Graphics
  - Intel Standard Manageability (ISM) comes standard for Intel® Core™ and Pentium™ configurations
  - Optional Intel® vPro™ Technology upgrade with selected Core™ i5 and Core™ i7 processors (vPro™ is optional and requires factory configuration)<sup>4</sup>
- Processor support up to 65W for MT/SFF/AiO and up to 35W for Desktop Mini
- Intel® Optane™ memory available as optional feature
- Choice of Windows 10 Professional, Windows 10 Home, and FreeDOS
- Integrated 10/100/1000 Ethernet Controller, with optional Wi-Fi 6 (802.11ax) and Wi-Fi 5 (802.11ac) and Bluetooth®
- Up to 64GB of DDR4 Synchronous Dynamic Random Access Memory (SDRAM)
- Support for up to three video outputs via two standard video connectors and an optional third video port connector which provides the following choices: DisplayPort™, HDMI, VGA, or USB Type-C® with DisplayPort™ Output on MT/SFF/DM
- Reduce clutter on DM with single cable connection for power and video through USB Type-C® enabled displays with the optional USB- Type-C® port w/ DisplayPort Alt Mode and power intake via USB Type-C® Power Delivery up to 100W; reduce desktop footprint with the DM mounted behind a USB-C™ enabled display or enable a “All-in-One” experience by docking into HP Mini-in-One 24 Display
- New flexibility is delivered by the All-in-One that can be used as a full PC or as an additional display for another desktop or laptop PC via the new HDMI in functionality
- Optional Serial port available on all form factors
- Multiple HDD data drives set up in a SATA RAID array for MT/SFF
- Optimized chassis design for SFF enabling dual 2.5" internal storage drives
- Integrated accessory cable lock helps secure cabled mouse and keyboard on MT/SFF
- Trusted Platform Module (TPM) 2.0<sup>2</sup>
- HP BIOSphere Gen6
- HP Client Security Manager Gen6
- HP Sure Click
- HP Manageability Integration Kit Gen4
- HP Image Assistant Gen5
- HP Support Assistant
- High efficiency energy saving power supply
- ENERGY STAR® certified. EPEAT® 2019 registered where applicable. EPEAT® registration varies by country. See <http://www.epeat.net> for registration status by country.<sup>5</sup>
- TUV Low Blue Light certified for All-in-One. To reach maximum performance, Low Blue Light setting should be enabled in On-screen display (OSD) settings and Night light mode should be turned on in Windows®
- Optimized for Microsoft Teams for All-in-One
- Low halogen<sup>3</sup>
- All form factors undergo up to 13 MIL-STD tests<sup>6</sup>
- Dust filter available for MT/SFF/DM
- Protected by HP Services, including limited warranties up to 3-3-3 (terms and conditions vary by country; certain restrictions and exclusions apply); Care Packs available with up to 5 years Next Business Day Onsite Hardware Support
- Compliance with CE (Class B) / FCC (Class B) / UL (UL60950-1 / UL62368-1) / CSA (CSA C22.2 No.60950-1-07 / CSA C22.2 No. 62368-1-14) / ICES-003 / CCC / VCCI (Class B) / KCC (Class B)

1. Multi core is designed to improve performance of certain software products. Not all customers or software applications will necessarily benefit from use of this technology. Performance and clock frequency will vary depending on application workload and your hardware and software configurations. Intel's numbering, branding and/or naming is not a measurement of higher performance

2. In some scenarios, machines pre-configured with Windows OS or FreeDOS might ship with TPM turned off

3. External power supplies, power cords, cables and peripherals are not low halogen. Service parts obtained after purchase may not be low halogen.

## Standard Features and Configurable Components (availability may vary by country)

4. Some functionality of vPro technology, such as Intel Active management technology and Intel Virtualization technology, requires additional 3rd party software in order to run. Availability of future "virtual appliances" applications for Intel vPro technology is dependant on 3rd party software providers. Compatibility of this generation of Intel vPro technology-based hardware with future "virtual appliances" is yet to be determined.

5. Based on US EPEAT® registration according to IEEE 1680.1-2018 EPEAT®. Status varies by country. Visit <http://www.epeat.net> for more information.

6. MIL-STD drop test not performed for All-in-Ones. MIL-STD testing is not intended to demonstrate fitness for U.S. Department of Defense contract requirements or for military use. Test results are not a guarantee of future performance under these test conditions. Accidental damage requires an optional HP Accidental Damage Protection Care Pack.

**NOTE: See important legal disclosures for all listed specs in their respective features sections.**

Standard Features and Configurable Components (availability may vary by country)

## PRODUCT NAME

HP ProDesk 400 G6 Desktop Mini PC  
 HP ProDesk 400 G7 Small Form Factor PC  
 HP ProDesk 400 G7 Microtower PC  
 HP ProDesk 480 G7 PCI Microtower PC  
 HP ProOne 400 G6 20 All-in-One PC  
 HP ProOne 400 G6 24 All-in-One PC

## OPERATING SYSTEM

<b>Preinstalled</b>	Windows® 10 Pro 64 – HP recommends Windows 10 Pro <sup>1</sup> Windows® 10 Pro 64 (National Academic License) <sup>1,2</sup> Windows® 10 Home 64 <sup>1</sup> FreeDOS
<b>Web Support</b>	Windows® 10 Enterprise 64 (Web Support) <sup>1</sup>

1. Not all features are available in all editions or versions of Windows. Systems may require upgraded and/or separately purchased hardware, drivers, software or BIOS update to take full advantage of Windows functionality. Windows 10 is automatically updated, which is always enabled. ISP fees may apply and additional requirements may apply over time for updates. See <http://www.windows.com/>.

2. Some devices for academic use will automatically be updated to Windows 10 Pro Education with the Windows 10 Anniversary Update. Features vary; see <https://aka.ms/ProEducation> for Windows 10 Pro Education feature information.

**NOTE:** Your product does not support Windows 8 or Windows 7. In accordance with Microsoft’s support policy, HP does not support the Windows® 8 or Windows 7 operating system on products configured with Intel® and AMD® 7th generation and forward processors or provide any Windows® 8 or Windows 7 drivers on <http://www.support.hp.com>. A full list of HP products and the Windows 10 versions tested is available on the HP support website. <https://support.hp.com/us-en/document/c05195282>

## CHIPSET

	<u>DM</u>	<u>SFF</u>	<u>MT</u>	<u>AiO</u>
Intel® Q470	X	X	X	X

Standard Features and Configurable Components (availability may vary by country)

## PROCESSORS

### Intel® 10<sup>th</sup> Generation Core™ Processors

	<u>DM</u>	<u>SFF</u>	<u>MT</u>	<u>AiO</u>
Intel® Core™ i7-10700 Processor <sup>1</sup> 65W 2.9 GHz base frequency Up to 4.7 GHz max. turbo frequency with Intel® Turbo Boost Technology <sup>3</sup> 16 MB cache, 8 cores, 16 threads Intel® UHD Graphics 630 Supports DDR4 memory up to 2933 MT/s data rate Supports Intel® vPro™ Technology and Intel® Stable Image Platform Program (SIPP) <sup>4</sup>		X	X	X
Intel® Core™ i7-10700T Processor <sup>1</sup> 35W 2.0 GHz base frequency Up to 4.4 GHz max. turbo frequency with Intel® Turbo Boost Technology <sup>3</sup> 16 MB cache, 8 cores, 16 threads Intel® UHD Graphics 630 Supports DDR4 memory up to 2933 MT/s data rate Supports Intel® vPro™ Technology and Intel® Stable Image Platform Program (SIPP) <sup>4</sup>	X			X
Intel® Core™ i5-10600 Processor <sup>1</sup> 65W 3.3 GHz base frequency Up to 4.8 GHz max. turbo frequency with Intel® Turbo Boost Technology <sup>3</sup> 12 MB cache, 6 cores, 12 threads Intel® UHD Graphics 630 Supports DDR4 memory up to 2666 MT/s data rate Supports Intel® vPro™ Technology and Intel® Stable Image Platform Program (SIPP) <sup>4</sup>		X	X	X
Intel® Core™ i5-10600T Processor <sup>1</sup> 35W 2.4 GHz base frequency Up to 4.0 GHz max. turbo frequency with Intel® Turbo Boost Technology <sup>3</sup> 12 MB cache, 6 cores, 12 threads Intel® UHD Graphics 630 Supports DDR4 memory up to 2666 MT/s data rate Supports Intel® vPro™ Technology and Intel® Stable Image Platform Program (SIPP) <sup>4</sup>	X			X
Intel® Core™ i5-10500 Processor <sup>1</sup> 65W 3.1 GHz base frequency Up to 4.5 GHz max. turbo frequency with Intel® Turbo Boost Technology <sup>3</sup> 12 MB cache, 6 cores, 12 threads		X	X	X



Standard Features and Configurable Components (availability may vary by country)

<p>Intel® UHD Graphics 630                  Supports DDR4 memory up to 2666 MT/s data rate                  Supports Intel® vPro™ Technology and Intel® Stable Image Platform Program (SIPP)<sup>4</sup></p>				
<p>Intel® Core™ i5-10500T Processor<sup>1</sup>                  35W                  2.3 GHz base frequency                  Up to 3.8 GHz max. turbo frequency with Intel® Turbo Boost Technology<sup>3</sup>                  12 MB cache, 6 cores, 12 threads                  Intel® UHD Graphics 630                  Supports DDR4 memory up to 2666 MT/s data rate                  Supports Intel® vPro™ Technology and Intel® Stable Image Platform Program (SIPP)<sup>4</sup></p>	<b>X</b>			<b>X</b>
<p>Intel® Core™ i5-10400 Processor<sup>1</sup>                  65W                  2.9 GHz base frequency                  Up to 4.3 GHz max. turbo frequency with Intel® Turbo Boost Technology<sup>3</sup>                  12 MB cache, 6 cores, 12 threads                  Intel® UHD Graphics 630                  Supports DDR4 memory up to 2666 MT/s data rate</p>		<b>X</b>	<b>X</b>	<b>X</b>
<p>Intel® Core™ i5-10400T Processor<sup>1</sup>                  35W                  2.0 GHz base frequency                  Up to 3.6 GHz max. turbo frequency with Intel® Turbo Boost Technology<sup>3</sup>                  12 MB cache, 6 cores, 12 threads                  Intel® UHD Graphics 630                  Supports DDR4 memory up to 2666 MT/s data rate</p>	<b>X</b>			<b>X</b>
<p>Intel® Core™ i3-10320 Processor<sup>1</sup>                  65W                  3.8 GHz base frequency                  Up to 4.6 GHz max. turbo frequency with Intel® Turbo Boost Technology<sup>3</sup>                  8 MB cache, 4 cores, 8 threads                  Intel® UHD Graphics 630                  Supports DDR4 memory up to 2666 MT/s data rate</p>		<b>X</b>	<b>X</b>	<b>X</b>
<p>Intel® Core™ i3-10300 Processor<sup>1</sup>                  65W                  3.7 GHz base frequency                  Up to 4.4 GHz max. turbo frequency with Intel® Turbo Boost Technology<sup>3</sup>                  8 MB cache, 4 cores, 8 threads                  Intel® UHD Graphics 630                  Supports DDR4 memory up to 2666 MT/s data rate</p>	<b>X</b>	<b>X</b>	<b>X</b>	<b>X</b>

Standard Features and Configurable Components (availability may vary by country)

	<b>DM</b>	<b>SFF</b>	<b>MT</b>	<b>AiO</b>
Intel® Core™ i3-10300T Processor <sup>1</sup> 35W 3.0 GHz base frequency Up to 3.9 GHz max. turbo frequency with Intel® Turbo Boost Technology <sup>3</sup> 8 MB cache, 4 cores, 8 threads Intel® UHD Graphics 630 Supports DDR4 memory up to 2666 MT/s data rate	<b>X</b>			<b>X</b>
Intel® Core™ i3-10100 Processor <sup>1</sup> 65W 3.6 GHz base frequency Up to 4.3 GHz max. turbo frequency with Intel® Turbo Boost Technology <sup>3</sup> 6 MB cache, 4 cores, 8 threads Intel® UHD Graphics 630 Supports DDR4 memory up to 2666 MT/s data rate		<b>X</b>	<b>X</b>	<b>X</b>
Intel® Core™ i3-10100T Processor <sup>1</sup> 35W 3.0 GHz base frequency Up to 3.8 GHz max. turbo frequency with Intel® Turbo Boost Technology <sup>3</sup> 6 MB cache, 4 cores, 8 threads Intel® UHD Graphics 630 Supports DDR4 memory up to 2666 MT/s data rate	<b>X</b>			<b>X</b>

## Intel® Pentium® Processors

	<b>DM</b>	<b>SFF</b>	<b>MT</b>	<b>AiO</b>
Intel® Pentium® Gold G-6600 Processor <sup>1</sup> 58W 4.2 GHz base frequency 4 MB cache, 2 cores, 4 threads Intel® UHD Graphics 630 Supports DDR4 memory up to 2666 MT/s data rate		<b>X</b>	<b>X</b>	<b>X</b>
Intel® Pentium® Gold G-6500 Processor <sup>1</sup> 58W 4.1 GHz base frequency 4 MB cache, 2 cores, 4 threads Intel® UHD Graphics 630 Supports DDR4 memory up to 2666 MT/s data rate		<b>X</b>	<b>X</b>	<b>X</b>
Intel® Pentium® Gold G-6500T Processor <sup>1</sup> 35W 3.5 GHz base frequency 4 MB cache, 2 cores, 4 threads Intel® UHD Graphics 630 Supports DDR4 memory up to 2666 MT/s data rate	<b>X</b>			<b>X</b>

Standard Features and Configurable Components (availability may vary by country)

	<b><u>DM</u></b>	<b><u>SFF</u></b>	<b><u>MT</u></b>	<b><u>AiO</u></b>
Intel® Pentium® Gold G-6400 Processor <sup>1</sup> 58W 4.0 GHz base frequency 4 MB cache, 2 cores, 4 threads Intel® UHD Graphics 610 Supports DDR4 memory up to 2666 MT/s data rate		<b>X</b>	<b>X</b>	
Intel® Pentium® Gold G-6400T Processor <sup>1</sup> 35W 3.4 GHz base frequency 4 MB cache, 2 cores, 4 threads Intel® UHD Graphics 610 Supports DDR4 memory up to 2666 MT/s data rate	<b>X</b>			<b>X</b>

- 1: Multi-core is designed to improve performance of certain software products. Not all customers or software applications will necessarily benefit from use of this technology. Performance and clock frequency will vary depending on application workload and your hardware and software configurations. Intel's numbering, branding and/or naming is not a measurement of higher performance.
2. Intel® Optane™ memory system acceleration does not replace or increase the DRAM in your system.
3. Intel® Turbo Boost technology requires a PC with a processor with Intel Turbo Boost capability. Intel Turbo Boost performance varies depending on hardware, software and overall system configuration. See [www.intel.com/technology/turboboost](http://www.intel.com/technology/turboboost) for more information.
4. Some functionality of vPro technology, such as Intel Active management technology and Intel Virtualization technology, requires additional 3<sup>rd</sup> party software in order to run. Availability of future "virtual appliances" applications for Intel vPro technology is dependent on 3<sup>rd</sup> party software providers. Compatibility with future "virtual appliances" is yet to be determined.

**NOTE:** Memory speed 2666 and 2933 MT/s can be achieved via two UDIMMs per channel (2DPC) when populated with the same part number.

Standard Features and Configurable Components (availability may vary by country)

## GRAPHICS

### Integrated Graphics

	<u>DM</u>	<u>SFF</u>	<u>MT</u>	<u>AiO</u>
Intel® UHD Graphics 630 (integrated on 10 <sup>th</sup> gen Core i7/i5/i3 processors and Pentium® Gold G-6600, G-6500 and G-6500T)	X	X	X	X
Intel® UHD Graphics 610 (integrated on Pentium® Gold G-6400, G-6400T)	X	X	X	X

### Optional Discrete Graphics Solutions

	<u>DM</u>	<u>SFF</u>	<u>MT</u>	<u>AiO</u>
AMD® Radeon™ R7 430 2GB 2DP		X	X	
AMD® Radeon™ R7 430 2GB DP+VGA		X	X	
AMD® Radeon™ 520 1GB VGA +DP			X	
AMD® Radeon™ RX 550X 4GB DP+HDMI		X	X	
AMD® Radeon™ 630 with 2GB GDDR5*				X

\*AMD® Radeon™ 630 with 2GB GDDR5 must be configured at purchase

### Adapters and Cables

	<u>DM</u>	<u>SFF</u>	<u>MT</u>	<u>AiO</u>
HP DisplayPort™ Cable	X	X	X	X
HP DisplayPort™ to DVI-D Adapter	X	X	X	X
HP DisplayPort™ to HDMI True 4K Adapter	X	X	X	X
HP DisplayPort™ to VGA Adapter	X	X	X	X
HP USB to Serial Port Adapter	X	X	X	X

## STORAGE

### 3.5 inch SATA Hard Disk Drives (HDD)

	<u>DM</u>	<u>SFF</u>	<u>MT</u>	<u>AiO</u>
500GB 7200RPM 3.5in SATA HDD		X	X	
1TB 7200RPM 3.5in SATA HDD		X	X	
2TB 7200RPM 3.5in SATA HDD		X	X	

### 2.5 inch SATA Hard Disk Drives (HDD)

	<u>DM</u>	<u>SFF</u>	<u>MT</u>	<u>AiO</u>
500GB 7200RPM 2.5in SATA HDD	X	X	X	X
1TB 7200RPM 2.5in SATA HDD	X	X	X	X
2TB 5400RPM 2.5in SATA HDD	X	X	X	X
500GB 7200RPM 2.5in Self Encrypted OPAL2 SATA HDD*	X	X	X	X
500GB 7200RPM 2.5in Self Encrypted Federal Information Processing Standard SATA HDD*	X	X	X	X

\* Storage DriveLock does not work with Self Encrypting or Optane based storage

### M.2 PCIe NVMe Solid State Drives (SSD)

	<u>DM</u>	<u>SFF</u>	<u>MT</u>	<u>AiO</u>
256GB M.2 2280 PCIe NVMe SSD	X	X	X	X
512GB M.2 2280 PCIe NVMe SSD	X	X	X	X
128GB M.2 2280 PCIe NVMe Three Layer Cell SSD	X	X	X	X

Standard Features and Configurable Components (availability may vary by country)

256GB M.2 2280 PCIe NVMe Three Layer Cell SSD	X	X	X	X
512GB M.2 2280 PCIe NVMe Three Layer Cell SSD	X	X	X	X
1TB M.2 2280 PCIe NVMe Three Layer Cell SSD	X	X	X	X
256GB M.2 2280 PCIe NVMe Self Encrypted OPAL2 Three Layer Cell SSD*	X	X	X	X
512GB M.2 2280 PCIe NVMe Self Encrypted OPAL2 Three Layer Cell SSD*	X	X	X	X
256GB Intel® Optane™ Memory H10 with Solid State Storage*	X	X	X	X
512GB Intel® Optane™ Memory H10 with Solid State Storage*	X	X	X	X

\* Storage DriveLock does not work with Self Encrypting or Optane based storage

### Optical Disc Drives

	<u>DM</u>	<u>SFF</u>	<u>MT</u>	<u>AiO</u>
HP 9.5mm Slim DVD-ROM Drive <sup>1</sup>		X	X	X
HP 9.5mm Slim DVD Writer Drive <sup>2</sup>		X	X	X
HP 9.5mm Slim Blu-Ray Writer Drive <sup>3</sup>		X	X	X

1. HD-DVD disks cannot be played on this drive. No support for DVD-RAM. Actual speeds may vary. Don't copy copyright-protected materials. Double Layer discs can store more data than single layer discs. Discs burned with this drive may not be compatible with many existing single-layer DVD drives and players.

2. Don't copy copyright-protected materials.

3. With Blu-Ray, certain disc, digital connection, compatibility and/or performance issues may arise, and do not constitute defects in the product. Flawless playback on all systems is not guaranteed. In order for some Blu-ray titles to play, they may require a DVI or HDMI digital connection and your display may require HDCP support. HD-DVD movies cannot be played on this Desktop PC.

### Media Card Reader

	<u>DM</u>	<u>SFF</u>	<u>MT</u>	<u>AiO</u>
SD 4.0 with 5-in-1 Interface (Supports SD, SDXC, SDHC, UHS-I, UHS-II)		X	X	
SD 3.0 with 4-in-1 Interface (Supports SD, SDXC, SDHC, UHS-I)				X

**NOTE:** For hard drives and solid state drives, GB = 1 billion bytes. TB = 1 trillion bytes. Actual formatted capacity is less. Up to 36 GB (for Windows 10) of system disk is reserved for the system recovery software.

## MEMORY

	<u>DM</u>	<u>SFF</u>	<u>MT</u>	<u>AiO</u>
DDR4-2666 (Transfer rates up to 2666 MT/s), 64 GB, 2 SODIMM	X			X
DDR4-2666 (Transfer rates up to 2666 MT/s), 64 GB, 2 DIMM		X	X	
DDR4-3200 (Transfer rates up to 3200 MT/s), 64 GB, 2 SODIMM	X			X
DDR4-3200 (Transfer rates up to 3200 MT/s), 64 GB, 2 DIMM		X	X	

### Memory Configuration

4 GB (4 GB x 1)	X	X	X	X
8 GB (4 GB x 2)	X	X	X	X
8 GB (8 GB x 1)	X	X	X	X
16 GB (8 GB x 2)	X	X	X	X
16 GB (16 GB x 1)	X	X	X	X
32 GB (16 GB x 2)	X	X	X	X
32 GB (32 GB x 1)	X	X	X	X

Standard Features and Configurable Components (availability may vary by country)

64 GB (32 GB x 2)	<b>X</b>	<b>X</b>	<b>X</b>	<b>X</b>
-------------------	----------	----------	----------	----------

**NOTE:** For systems configured with more than 3 GB of memory and a 32-bit operating system, all memory may not be available due to system resource requirements. Addressing memory above 4 GB requires a 64-bit operating system.

**NOTE:** Memory modules support data transfer rates up to 2666 MT/s and 3200 MT/s respectively depending on memory module used; actual data rate is determined by the system's configured processor. See processor specifications for supported memory data rate.

**NOTE:** All memory slots are customer accessible / upgradeable.

**NOTE:** Memory speed 2666 and 2933 MT/s can be achieved via two UDIMMs per channel (2DPC) when populated with the same part number.

## NETWORKING/COMMUNICATIONS

### Ethernet (RJ-45)

	<b>DM</b>	<b>SFF</b>	<b>MT</b>	<b>AiO</b>
Intel® I219-LM Gigabit Network Connection (standard)	<b>X</b>	<b>X</b>	<b>X</b>	<b>X</b>
Intel® I210-T1 PCIe x1 Gigabit Network Interface Card (optional)		<b>X</b>	<b>X</b>	

### Wireless<sup>1</sup>

Intel® Wi-Fi 6 AX201 802.11ax 2x2 with Bluetooth® M.2 Combo Card vPro™	<b>X</b>	<b>X</b>	<b>X</b>	<b>X</b>
Intel® Wi-Fi 6 AX201 802.11ax 2x2 with Bluetooth® M.2 Combo Card non-vPro™	<b>X</b>	<b>X</b>	<b>X</b>	<b>X</b>
Realtek RTL8822CE 802.11ac 2x2 with Bluetooth® M.2 Combo Card	<b>X</b>	<b>X</b>	<b>X</b>	<b>X</b>
Realtek RTL8821CE 802.11ac 1x1 with Bluetooth® M.2 Combo Card	<b>X</b>	<b>X</b>	<b>X</b>	<b>X</b>

1. Wireless access point and Internet service required and not included. Availability of public wireless access points limited.

## KEYBOARDS AND POINTING DEVICES

### Keyboards

	<b>DM</b>	<b>SFF</b>	<b>MT</b>	<b>AiO</b>
HP PS/2 Business Slim Standalone Wired Keyboard		<b>X</b>	<b>X</b>	
HP Wired Desktop 320K Keyboard	<b>X</b>	<b>X</b>	<b>X</b>	<b>X</b>
HP USB Business Slim Wired SmartCard CCID Keyboard	<b>X</b>	<b>X</b>	<b>X</b>	<b>X</b>
HP USB & PS/2 Washable Standalone Wired Keyboard	<b>X</b>	<b>X</b>	<b>X</b>	<b>X</b>
HP USB Wired Keyboard	<b>X</b>	<b>X</b>	<b>X</b>	<b>X</b>
HP Universal USB Wired Keyboard	<b>X</b>	<b>X</b>	<b>X</b>	<b>X</b>

### Keyboard & Mouse Combo

	<b>DM</b>	<b>SFF</b>	<b>MT</b>	<b>AiO</b>
HP Business Slim Wireless Keyboard and Mouse	<b>X</b>	<b>X</b>	<b>X</b>	<b>X</b>
HP USB PS/2 Washable Keyboard and Mouse Wired	<b>X</b>	<b>X</b>	<b>X</b>	<b>X</b>

### Mouse

	<b>DM</b>	<b>SFF</b>	<b>MT</b>	<b>AiO</b>
HP PS/2 Mouse		<b>X</b>	<b>X</b>	
HP Wired Desktop 320M Mouse	<b>X</b>	<b>X</b>	<b>X</b>	<b>X</b>
HP USB Optical Wired Mouse	<b>X</b>	<b>X</b>	<b>X</b>	<b>X</b>
HP USB Hardened Optical Wired Mouse	<b>X</b>	<b>X</b>	<b>X</b>	<b>X</b>
HP USB 1000dpi Laser Mouse	<b>X</b>	<b>X</b>	<b>X</b>	<b>X</b>
HP USB & PS/2 Washable Wired Mouse Standalone	<b>X</b>	<b>X</b>	<b>X</b>	<b>X</b>
HP USB Fingerprint Mouse	<b>X</b>	<b>X</b>	<b>X</b>	<b>X</b>

Standard Features and Configurable Components (availability may vary by country)

**NOTE:** Availability may vary by country

## SECURITY

	<b>DM</b>	<b>SFF</b>	<b>MT</b>	<b>AiO</b>
TPM 2.0 (FW: 7.85) endpoint security controller (Infineon SLB9670) shipped with Windows 10. Common Criteria EAL4+ Certified. FIPS 140-2 Level 2 Certified.	<b>X</b>	<b>X</b>	<b>X</b>	<b>X</b>
Intrusion Sensor (Optional)		<b>X</b>	<b>X</b>	
Intrusion Sensor (integrated in the system board, can be enabled/disabled through BIOS)	<b>X</b>			<b>X</b>
Support for chassis cable lock devices	<b>X</b> (10 mm barrel or smaller)	<b>X</b>	<b>X</b>	<b>X</b>
Support for chassis padlocks devices	<b>X</b>	<b>X</b>	<b>X</b>	
Support for table lock				<b>X</b>
SATA port disablement (via BIOS)	<b>X</b>	<b>X</b>	<b>X</b>	<b>X</b>
Serial, USB enable/disable (via BIOS)	<b>X</b>	<b>X</b>	<b>X</b>	<b>X</b>
Intel® Identify Protection Technology (IPT) <sup>1</sup>	<b>X</b>	<b>X</b>	<b>X</b>	<b>X</b>
Removable media write/boot control	<b>X</b>	<b>X</b>	<b>X</b>	<b>X</b>
Power-on password (via BIOS)	<b>X</b>	<b>X</b>	<b>X</b>	<b>X</b>
Setup password (via BIOS)	<b>X</b>	<b>X</b>	<b>X</b>	<b>X</b>

1. Models configured with Intel® Core™ processors have the ability to utilize advanced security protection for online transactions. IPT, used in conjunction with participating web sites, provides double identity authentication by adding a hardware component in addition to the usual user name and password. IPT is initialized through an HP Client Security module

Standard Features and Configurable Components (availability may vary by country)

## PORTS

### Internal Slots and Ports

	<u>DM</u>	<u>SFF</u>	<u>MT</u>		<u>AiO</u>
			400	480 PCI	
M.2 PCIe	(1) M.2 PCIe x1 2230 (for WLAN) (1) M.2 PCIe x4 2280 (for storage)	(1) M.2 PCIe x1 2230 (for WLAN) (1) M.2 PCIe x4 2280 (for storage)	(1) M.2 PCIe x1 2230 (for WLAN) (1) M.2 PCIe x4 2280 (for storage)	(1) M.2 PCIe x1 2230 (for WLAN) (1) M.2 PCIe x4 2280 (for storage)	
PCI Express v3.0 x1		1	2	1	
PCI Express v3.0 x16		1	1	1	
PCI x1				1	
SATA port		3	3		
Integrated SATA storage connector	1				1

**NOTE:** For Desktop Mini with M.2 Storage config, there will be no SATA drive bracket. If you plan to use or upgrade the storage with any 2.5" SATA drive, please select a DM SATA Drive Bracket (available as both factory configured and after market option).

### Bays

	<u>DM</u>	<u>SFF</u>	<u>MT</u>	<u>AiO</u>
9.5mm Slim Optical Disc Drive (ODD)		1	1	1 <sup>1</sup>
SD Card Reader		1	1	1
2.5" Internal Storage Drive	1	2 <sup>2</sup>	1	1
3.5" Internal Storage Drive		1 <sup>2</sup>	2 <sup>3</sup>	

1. Must be configured at time of purchase
2. SFF can be configured with either (1) 3.5" or (2) 2.5" internal storage drive (2.5-inch drive needs adapter that can only be purchased when configuring the PC from factory with a 2.5" drive.)
3. MT's one of the 3.5" bay can be configured as either (1) 3.5" internal storage drive bay or (1) 2.5" internal storage drive bay (2.5-inch drive needs an adapter that can only be purchased when configuring the PC from factory with a 2.5" drive.)

### Standard User Accessible Ports

	<u>DM</u>	<u>SFF</u>	<u>MT</u>		<u>AiO</u>
			400	480 PCI	
Type-A Hi-Speed USB 480Mbps signaling rate port	2 <sup>1</sup> (rear)	2 (front) 2 (rear)	2 (front) 2 (rear)	4 (rear)	
Type-A SuperSpeed USB 5Gbps signaling rate port	1 (front) 2 (rear)	3 (rear)	3 (rear)	4 (front)	4 (rear)
Type-A SuperSpeed USB 10Gbps signaling rate port	1 (front)	2 (front)	2 (front)	2 (front)	1 (side)
Type-C® SuperSpeed USB 10Gbps signaling rate port	1 (front)				1 (side)
Video	1 DisplayPort™ 1.4 (rear) 1 HDMI 1.4 (rear)	1 DisplayPort™ 1.4 (rear) 1 HDMI 1.4 (rear)	1 DisplayPort™ 1.4 (rear) 1 HDMI 1.4 (rear)	1 DisplayPort™ 1.4 (rear) 1 VGA (rear)	1 DisplayPort™ 1.4 (rear) 1 HDMI 1.4 in (rear)
Audio	1 Combo Audio Jack with CTIA and OMTP	1 Combo Audio Jack with CTIA and OMTP	1 Combo Audio Jack with CTIA and OMTP headset support (front)		1 Combo Audio Jack with CTIA and OMTP



Standard Features and Configurable Components (availability may vary by country)

	headset support (front)	headset support (front)		OMTP headset support (side)
Network Interface	1 RJ45 (rear)	1 RJ45 (rear)	1 RJ45 (rear)	1 RJ45 (rear)

1. Upgradeable to SuperSpeed USB 10Gbps signaling rate port if configured with additional digital video port via Flex Port 1 and/or Intel® vPro™

### Rear Configurable Non-PCIe/PCI Slot User Accessible Ports

Flexible Port 1, choice of one of the following:

	<u>DM</u>	<u>SFF</u>	<u>MT</u> 400	480 PCI	<u>AiO</u>
Type-A USB		2 Type-A SuperSpeed USB 5Gbps signaling rate port	2 Type-A SuperSpeed USB 5Gbps signaling rate port		
Type-C® USB	1 SuperSpeed USB 10Gbps signaling rate port w/ DisplayPort™ Alt Mode and power intake via USB Type-C® Power Delivery up to 100W	1 SuperSpeed USB 10Gbps signaling rate port w/ DisplayPort™ Alt Mode	1 SuperSpeed USB 10Gbps signaling rate port w/ DisplayPort™ Alt Mode		
Video	1 DisplayPort™ 1.4 <u>or</u> HDMI 2.0 <u>or</u> VGA	1 DisplayPort™ 1.4 <u>or</u> HDMI 2.0 <u>or</u> VGA	1 DisplayPort™ 1.4 <u>or</u> HDMI 2.0 <u>or</u> VGA		1 DisplayPort™ 1.4 <u>or</u> HDMI 2.0
Serial (RS-232)	1 <sup>1</sup>	1	1		1

1. Sold separately or as an optional feature

(1) Flexible Port 2, choice of one of the following:

	<u>DM</u>	<u>SFF</u>	<u>MT</u>	<u>AiO</u>
Type-A USB	2 Hi-Speed USB 480Mbps signaling rate port <sup>1</sup>			
Serial (RS-232)	1 <sup>1</sup>	1 <sup>1</sup>	1 <sup>1</sup>	

1. Must be configured at time of purchase

Standard Features and Configurable Components (availability may vary by country)

## USB SPECIFICATION AND MARKETING NAME MAPPING TABLE

Marketing Name	Technical Terminology
Hi-Speed USB 480Mbps signaling rate	USB 2.0
SuperSpeed USB 5Gbps signaling rate	USB 3.2 Gen 1
SuperSpeed USB 10Gbps signaling rate	USB 3.2 Gen 2
SuperSpeed USB 20Gbps signaling rate	USB 3.2 Gen 2x2

Standard Features and Configurable Components (availability may vary by country)

## SOFTWARE COMPONENTS AND APPLICATIONS WITH WINDOWS

### Preinstalled Software

HP BIOSphere Gen6<sup>17</sup>  
HP Secure Erase<sup>18</sup>  
HP DriveLock & Automatic DriveLock<sup>20</sup>  
BIOS Update via Network  
Absolute Persistence Module<sup>19</sup>  
Pre-boot Authentication

### Software

HP Desktop Support Utility  
HP JumpStarts  
HP Privacy Settings  
HP Setup Integrated OOBE  
HP Support Assistant<sup>21</sup>  
HP Noise Cancellation Software  
Buy Office (sold separately)  
Xerox® DocuShare® (90 day free trial offer)<sup>26</sup>

### Manageability Features

HP Driver Packs<sup>22</sup>  
HP System Software Manager (SSM) (download)  
HP BIOS Config Utility (BCU) (download)  
HP Cloud Recovery<sup>38</sup>  
HP Client Catalog (download)  
HP Manageability Integration Kit for Microsoft System Center Configuration Management Gen4<sup>23</sup>  
HP Image Assistant Gen5  
Ivanti Management Suite (download)<sup>24</sup>

### Client Security Software

HP Client Security Manager Gen6<sup>25</sup>  
HP Power On Authentication  
Windows Defender<sup>27</sup>

### Security Management

Trusted Platform Module TPM 2.0 Embedded Security Chip shipped with Windows 10. (Common Criteria EAL4+ Certified)  
Serial, USB enable/disable (via BIOS)  
Power-on password (via BIOS)  
Setup password (via BIOS)  
HP Sure Sense<sup>34</sup>  
HP Sure Click<sup>37</sup>

17. HP BIOSphere Gen6 is available on select HP Pro and Elite PCs. Features may vary depending on the platform and configurations.

18. Secure Erase for the methods outlined in the National Institute of Standards and Technology Special Publication 800-88. "Clear" sanitation method. HP Secure Erase does not support platforms with Intel® Optane™.

19. Absolute agent is shipped turned off, and will be activated when customers activate a purchased subscription. Subscriptions can be purchased for terms ranging multiple years. Service is limited, check with Absolute for availability outside the U.S. The Absolute Recovery Guarantee is a limited warranty. Certain conditions apply. For full details visit: <http://www.absolute.com/company/legal/agreements/computrace-agreement>. Data Delete is an optional service provided by Absolute Software. If utilized, the Recovery Guarantee is null and void. In order to use the Data Delete service, customers must first sign a Pre-Authorization Agreement and either obtain a PIN or purchase one or more RSA SecurID tokens from Absolute Software.

20. Storage DriveLock does not work with Self Encrypting or Optane based storage

21. HP Support Assistant requires Windows and Internet access.

22. HP Driver Packs not preinstalled, however available for download at <http://www.hp.com/go/clientmanagement>.

23. HP Manageability Integration Kit can be downloaded from <http://www8.hp.com/us/en/ads/clientmanagement/overview.html>

24. Ivanti Management Suite subscription required.

## Standard Features and Configurable Components (availability may vary by country)

25. HP Client Security Manager Gen6 requires Windows and is available on the select HP Elite and Pro PCs.
26. Simply sign up and start using Xerox® DocuShare® Go. No credit card. No obligation. Data will become unavailable unless a subscription is entered before the end of the 90 day free trial period. See visit <http://www.xerox.com/docusharego> for details.
27. Windows Defender Opt In, Windows 10, and internet connection required for updates.
37. HP Sure Click requires Windows 10 and supports Microsoft Internet Explorer, Google Chrome™, and Chromium™. Supported attachments include Microsoft Office (Word, Excel, PowerPoint) and PDF files in read only mode, when Microsoft Office or Adobe Acrobat are installed.
38. HP Cloud Recovery is available for HP Elite and Pro desktops and laptops PCs with Intel® or AMD processors and requires an open, wired network connection (DM/AiO). Note: You must back up important files, data, photos, videos, etc. before use to avoid loss of data. Detail please refer to: <https://support.hp.com/us-en/document/c05115630>.

Standard Features and Configurable Components (availability may vary by country)

## UNIT ENVIRONMENT AND OPERATING CONDITIONS

### General Unit Operating Guidelines

- Keep the computer away from excessive moisture, direct moisture and the extremes of heat and cold, to ensure that unit is operated within the specified operating range.
- Leave a 10.2 cm (4 in) clearance on all vented sides of the computer to permit the required airflow.
- Never restrict airflow into the computer by blocking any vents or air intakes.
- Do not stack computers on top of each other or place computers so near each other that they are subject to each other's re-circulated or preheated air.
- Occasionally clean the air vents on the front, back, and any other vented side of the computer. Lint, dust and other foreign matter can block the vents and limit the airflow.
- If the computer is to be operated within a separate enclosure, intake and exhaust ventilation must be provided on the enclosure, and the same operating guidelines listed above will still apply.

Temperature Range	Operating: 5° to 35° C <sup>1</sup> Non-Operating for AiO: -20° to 60° C <sup>1</sup> Non-Operating for MT/SFF/DM: -30° to 60° C <sup>1</sup>
Relative Humidity	Operating: 5% to 90% (non-condensing at ambient) Non-operating: 5% to 90% (non-condensing at ambient)
Maximum Altitude (unpressurized)	Operating: 5000m Non-operating: 50000ft (15240 m)

1. Operating temperature is de-rated 1.0 deg C per 300 m (1000 ft) to 3000 m (10,000 ft) above sea level, no direct sustained sunlight. Maximum rate of change is 10 deg C/Hr. The upper limit may be limited by the type and number of options installed.

Standard Features and Configurable Components (availability may vary by country)

## ENVIRONMENTAL & INDUSTRY

### HP ProDesk 400 G6 Desktop Mini PC

<b>Eco-Label Certifications &amp; declarations</b>	<p>This product has received or is in the process of being certified to the following approvals and may be labeled with one or more of these marks:</p> <ul style="list-style-type: none"> <li>• IT ECO declaration</li> <li>• US ENERGY STAR® certified</li> <li>• EPEAT® 2019 registered where applicable. EPEAT® registration varies by country. See <a href="http://www.epeat.net">http://www.epeat.net</a> for registration status in your country*. Search keyword generator on HP's 3rd party option store for solar generator accessories at <a href="http://www.hp.com/go/options">http://www.hp.com/go/options</a>.</li> <li>• TCO Certified 8.0</li> </ul> <p>*Based on US EPEAT® registration according to IEEE 1680.1-2018 EPEAT®. Status varies by country. Visit <a href="http://www.epeat.net">http://www.epeat.net</a> for more information.</p>		
<b>System Configuration</b>	<p>The configuration used for the Energy Consumption and Declared Noise Emissions data for the Desktop model is based on a Typically Configured Desktop.</p>		
<b>Energy Consumption (in accordance with US ENERGY STAR® test method)</b>	<b>115VAC, 60Hz</b>	<b>230VAC, 50Hz</b>	<b>100VAC, 60Hz</b>
Normal Operation (Short idle)	4.52 W	4.55 W	4.49 W
Normal Operation (Long idle)	3.85 W	3.86 W	3.84 W
Sleep	0.62 W	0.67 W	0.60 W
Off	0.55 W	0.55 W	0.55 W
	<p><b>NOTE:</b> Energy efficiency data listed is for an ENERGY STAR® certified product if offered within the model family. HP computers marked with the ENERGY STAR® Logo are certified with the applicable U.S. Environmental Protection Agency (EPA) ENERGY STAR® specifications for computers. If a model family does not offer ENERGY STAR® certified configurations, then energy efficiency data listed is for a typically configured PC featuring a hard disk drive, a high efficiency power supply, and a Microsoft Windows® operating system.</p>		
<b>Heat Dissipation*</b>	<b>115VAC, 60Hz</b>	<b>230VAC, 50Hz</b>	<b>100VAC, 50Hz</b>
Normal Operation (Short idle)	15 BTU/hr	16 BTU/hr	15 BTU/hr
Normal Operation (Long idle)	13 BTU/hr	13 BTU/hr	13 BTU/hr
Sleep	2 BTU/hr	2 BTU/hr	2 BTU/hr
Off	2 BTU/hr	2 BTU/hr	2 BTU/hr
	<p><b>NOTE:</b> Heat dissipation is calculated based on the measured watts, assuming the service level is attained for one hour.</p>		
<b>Declared Noise Emissions (in accordance with ISO 7779 and ISO 9296)</b>	<b>Sound Power (L<sub>WAd</sub>, bels)</b>		<b>Sound Pressure (L<sub>pAm</sub>, decibels)</b>
Typically Configured – Idle	2.9		19
Fixed Disk – Random writes	3.2		21.4
<b>Longevity and Upgrading</b>	<p>This product can be upgraded, possibly extending its useful life by several years. Upgradeable features and/or components contained in the product may include:</p> <ul style="list-style-type: none"> <li>• 2 SODIMM memory slots</li> <li>• Interchangeable M.2 PCIe NVME SSD &amp; 2.5" SATA HDD</li> </ul>		

Standard Features and Configurable Components (availability may vary by country)

	Spare parts are available throughout the warranty period and or for up to “5” years after the end of production.		
Batteries	<p>This battery(s) in this product comply with EU Directive 2006/66/EC</p> <p>Batteries used in the product do not contain:                  Mercury greater than 1ppm by weight                  Cadmium greater than 20ppm by weight</p> <p>Battery size: CR2032 (coin cell)                  Battery type: Lithium</p>		
<b>Additional Information</b>	<ul style="list-style-type: none"> <li>• This product is in compliance with the Restrictions of Hazardous Substances (RoHS) directive - 2011/65/EC.</li> <li>• This HP product is designed to comply with the Waste Electrical and Electronic Equipment (WEEE) Directive – 2002/96/EC.</li> <li>• This product is in compliance with California Proposition 65 (State of California; Safe Drinking Water and Toxic Enforcement Act of 1986).</li> <li>• Plastics parts weighing over 25 grams used in the product are marked per ISO11469 and ISO1043.</li> <li>• This product contains a minimum of 35% post-consumer recycled (PCR) plastic (by wt.); including 10% ITE-derived post-consumer recycled plastic.*</li> <li>• This product is 95.1% recycle-able when properly disposed of at end of life.</li> </ul> <p>*Recycled plastic content percentage is based on the definition set in the IEEE 1680.1-2018 standard.</p>		
<b>Packaging Materials</b> (vary by country)	<b>External:</b>	PAPER/Paper	450 g
	<b>Internal:</b>	PAPER/Molded Pulp	74 g
		PLASTIC/Polyethylene low density - LDPE	5 g
<b>Material Usage</b>	<p>This product does not contain any of the following substances in excess of regulatory limits (refer to the HP General Specification for the Environment at <a href="http://www.hp.com/hpinfo/globalcitizenship/environment/pdf/gse.pdf">http://www.hp.com/hpinfo/globalcitizenship/environment/pdf/gse.pdf</a>):</p> <ul style="list-style-type: none"> <li>• Asbestos</li> <li>• Certain Azo Colorants</li> <li>• Certain Brominated Flame Retardants – may not be used as flame retardants in plastics</li> <li>• Cadmium</li> <li>• Chlorinated Hydrocarbons</li> <li>• Chlorinated Paraffins</li> <li>• Formaldehyde</li> <li>• Halogenated Diphenyl Methanes</li> <li>• Lead carbonates and sulfates</li> <li>• Lead and Lead compounds</li> <li>• Mercuric Oxide Batteries</li> <li>• Nickel – finishes must not be used on the external surface designed to be frequently handled or carried by the user.</li> <li>• Ozone Depleting Substances</li> <li>• Polybrominated Biphenyls (PBBs)</li> <li>• Polybrominated Biphenyl Ethers (PBBEs)</li> <li>• Polybrominated Biphenyl Oxides (PBBOs)</li> <li>• Polychlorinated Biphenyl (PCB)</li> <li>• Polychlorinated Terphenyls (PCT)</li> <li>• Polyvinyl Chloride (PVC) – except for wires and cables, and certain retail packaging has been voluntarily removed from most applications.</li> <li>• Radioactive Substances</li> <li>• Tributyl Tin (TBT), Triphenyl Tin (TPT), Tributyl Tin Oxide (TBTO)</li> </ul>		

Standard Features and Configurable Components (availability may vary by country)

<p><b>Packaging Usage</b></p>	<p>HP follows these guidelines to decrease the environmental impact of product packaging:</p> <ul style="list-style-type: none"> <li>• Eliminate the use of heavy metals such as lead, chromium, mercury and cadmium in packaging materials.</li> <li>• Eliminate the use of ozone-depleting substances (ODS) in packaging materials.</li> <li>• Design packaging materials for ease of disassembly.</li> <li>• Maximize the use of post-consumer recycled content materials in packaging materials.</li> <li>• Use readily recyclable packaging materials such as paper and corrugated materials.</li> <li>• Reduce size and weight of packages to improve transportation fuel efficiency.</li> <li>• Plastic packaging materials are marked according to ISO 11469 and DIN 6120 standards.</li> </ul>
<p><b>End-of-life Management and Recycling</b></p>	<p>HP Inc. offers end-of-life HP product return and recycling programs in many geographic areas. To recycle your product, please go to: <a href="http://www.hp.com/go/reuse-recycle">http://www.hp.com/go/reuse-recycle</a> or contact your nearest HP sales office. Products returned to HP will be recycled, recovered or disposed of in a responsible manner.</p> <p>The EU WEEE directive (2002/95/EC) requires manufacturers to provide treatment information for each product type for use by treatment facilities. This information (product disassembly instructions) is posted on the Hewlett Packard web site at: <a href="http://www.hp.com/go/recyclers">http://www.hp.com/go/recyclers</a>. These instructions may be used by recyclers and other WEEE treatment facilities as well as HP OEM customers who integrate and re-sell HP equipment.</p> <p>Global Citizenship Report  <a href="http://www.hp.com/hpinfo/globalcitizenship/gcreport/index.html">http://www.hp.com/hpinfo/globalcitizenship/gcreport/index.html</a>  Eco-label certifications  <a href="http://www8.hp.com/us/en/hp-information/environment/ecolabels.html">http://www8.hp.com/us/en/hp-information/environment/ecolabels.html</a>  ISO 14001 certificates:  <a href="http://www.hp.com/hpinfo/globalcitizenship/environment/pdf/PC_GBU_Product_Design_ISO_14K_Certificate.pdf">http://www.hp.com/hpinfo/globalcitizenship/environment/pdf/PC_GBU_Product_Design_ISO_14K_Certificate.pdf</a>  and  <a href="http://www.hp.com/hpinfo/globalcitizenship/environment/pdf/cert.pdf">http://www.hp.com/hpinfo/globalcitizenship/environment/pdf/cert.pdf</a></p>



Standard Features and Configurable Components (availability may vary by country)

## HP ProDesk 400 G7 Small Form Factor PC

<b>Eco-Label Certifications &amp; declarations</b>	<p>This product has received or is in the process of being certified to the following approvals and may be labeled with one or more of these marks:</p> <ul style="list-style-type: none"> <li>• IT ECO declaration</li> <li>• US ENERGY STAR® certified</li> <li>• EPEAT® 2019 registered where applicable. EPEAT® registration varies by country. See <a href="http://www.epeat.net">http://www.epeat.net</a> for registration status in your country*. Search keyword generator on HP's 3rd party option store for solar generator accessories at <a href="http://www.hp.com/go/options">http://www.hp.com/go/options</a>.</li> <li>• TCO Certified</li> </ul> <p>*Based on US EPEAT® registration according to IEEE 1680.1-2018 EPEAT®. Status varies by country. Visit <a href="http://www.epeat.net">http://www.epeat.net</a> for more information</p>		
<b>System Configuration</b>	<p>The configuration used for the Energy Consumption and Declared Noise Emissions data for the Desktop model is based on a Typically Configured Desktop.</p>		
<b>Energy Consumption (in accordance with US ENERGY STAR® test method)</b>	<b>115VAC, 60Hz</b>	<b>230VAC, 50Hz</b>	<b>100VAC, 60Hz</b>
Normal Operation (Short idle)			
Normal Operation (Long idle)			
Sleep Off			
	<p><b>NOTE:</b> Energy efficiency data listed is for an ENERGY STAR® certified product if offered within the model family. HP computers marked with the ENERGY STAR® Logo are certified with the applicable U.S. Environmental Protection Agency (EPA) ENERGY STAR® specifications for computers. If a model family does not offer ENERGY STAR® certified configurations, then energy efficiency data listed is for a typically configured PC featuring a hard disk drive, a high efficiency power supply, and a Microsoft Windows® operating system.</p>		
<b>Heat Dissipation*</b>	<b>115VAC, 60Hz</b>	<b>230VAC, 50Hz</b>	<b>100VAC, 60Hz</b>
Normal Operation (Short idle)			
Normal Operation (Long idle)			
Sleep Off			
	<p><b>NOTE:</b> Heat dissipation is calculated based on the measured watts, assuming the service level is attained for one hour.</p>		
<b>Declared Noise Emissions (in accordance with ISO 7779 and ISO 9296)</b>	Sound Power (L <sub>WA</sub> d, bels)		Sound Pressure (L <sub>pAm</sub> , decibels)
Typically Configured – Idle			
Fixed Disk – Random writes			
Longevity and Upgrading	<p>This product can be upgraded, possibly extending its useful life by several years. Upgradeable features and/or components contained in the product may include:</p> <ul style="list-style-type: none"> <li>• 2 DIMM memory slots</li> <li>• Interchangeable M.2 PCIe NVME SSD &amp; 2.5"/3.5" SATA HDD</li> </ul>		

Standard Features and Configurable Components (availability may vary by country)

	Spare parts are available throughout the warranty period and or for up to “5” years after the end of production.	
Batteries	<p>This battery(s) in this product comply with EU Directive 2006/66/EC</p> <p>Batteries used in the product do not contain:                  Mercury greater than 1ppm by weight                  Cadmium greater than 20ppm by weight</p> <p>Battery size: CR2032 (coin cell)                  Battery type: Lithium</p>	
<b>Additional Information</b>	<ul style="list-style-type: none"> <li>• This product is in compliance with the Restrictions of Hazardous Substances (RoHS) directive - 2011/65/EC.</li> <li>• This HP product is designed to comply with the Waste Electrical and Electronic Equipment (WEEE) Directive – 2002/96/EC.</li> <li>• This product is in compliance with California Proposition 65 (State of California; Safe Drinking Water and Toxic Enforcement Act of 1986).</li> <li>• Plastics parts weighing over 25 grams used in the product are marked per ISO11469 and ISO1043.</li> <li>• This product contains a minimum of 35% post-consumer recycled (PCR) plastic (by wt.); including 10% ITE-derived post-consumer recycled plastic.*</li> <li>• This product is 95.1% recycle-able when properly disposed of at end of life.</li> </ul> <p>*Recycled plastic content percentage is based on the definition set in the IEEE 1680.1-2018 standard.</p>	
<b>Packaging Materials</b> (vary by country)	<b>External:</b>	PAPER/Corrugated
	<b>Internal:</b>	PLASTIC/EPE (Expanded Polyethylene)
		PLASTIC/Polyethylene low density
<b>Material Usage</b>	<p>This product does not contain any of the following substances in excess of regulatory limits (refer to the HP General Specification for the Environment at <a href="http://www.hp.com/hpinfo/globalcitizenship/environment/pdf/gse.pdf">http://www.hp.com/hpinfo/globalcitizenship/environment/pdf/gse.pdf</a>):</p> <ul style="list-style-type: none"> <li>• Asbestos</li> <li>• Certain Azo Colorants</li> <li>• Certain Brominated Flame Retardants – may not be used as flame retardants in plastics</li> <li>• Cadmium</li> <li>• Chlorinated Hydrocarbons</li> <li>• Chlorinated Paraffins</li> <li>• Formaldehyde</li> <li>• Halogenated Diphenyl Methanes</li> <li>• Lead carbonates and sulfates</li> <li>• Lead and Lead compounds</li> <li>• Mercuric Oxide Batteries</li> <li>• Nickel – finishes must not be used on the external surface designed to be frequently handled or carried by the user.</li> <li>• Ozone Depleting Substances</li> <li>• Polybrominated Biphenyls (PBBs)</li> <li>• Polybrominated Biphenyl Ethers (PBBEs)</li> <li>• Polybrominated Biphenyl Oxides (PBBOs)</li> <li>• Polychlorinated Biphenyl (PCB)</li> <li>• Polychlorinated Terphenyls (PCT)</li> <li>• Polyvinyl Chloride (PVC) – except for wires and cables, and certain retail packaging has been voluntarily removed from most applications.</li> <li>• Radioactive Substances</li> <li>• Tributyl Tin (TBT), Triphenyl Tin (TPT), Tributyl Tin Oxide (TBTO)</li> </ul>	

Standard Features and Configurable Components (availability may vary by country)

<p><b>Packaging Usage</b></p>	<p>HP follows these guidelines to decrease the environmental impact of product packaging:</p> <ul style="list-style-type: none"> <li>• Eliminate the use of heavy metals such as lead, chromium, mercury and cadmium in packaging materials.</li> <li>• Eliminate the use of ozone-depleting substances (ODS) in packaging materials.</li> <li>• Design packaging materials for ease of disassembly.</li> <li>• Maximize the use of post-consumer recycled content materials in packaging materials.</li> <li>• Use readily recyclable packaging materials such as paper and corrugated materials.</li> <li>• Reduce size and weight of packages to improve transportation fuel efficiency.</li> <li>• Plastic packaging materials are marked according to ISO 11469 and DIN 6120 standards.</li> </ul>
<p><b>End-of-life Management and Recycling</b></p>	<p>HP Inc. offers end-of-life HP product return and recycling programs in many geographic areas. To recycle your product, please go to: <a href="http://www.hp.com/go/reuse-recycle">http://www.hp.com/go/reuse-recycle</a> or contact your nearest HP sales office. Products returned to HP will be recycled, recovered or disposed of in a responsible manner.</p> <p>The EU WEEE directive (2002/95/EC) requires manufacturers to provide treatment information for each product type for use by treatment facilities. This information (product disassembly instructions) is posted on the Hewlett Packard web site at: <a href="http://www.hp.com/go/recyclers">http://www.hp.com/go/recyclers</a>. These instructions may be used by recyclers and other WEEE treatment facilities as well as HP OEM customers who integrate and re-sell HP equipment.</p> <p>Global Citizenship Report  <a href="http://www.hp.com/hpinfo/globalcitizenship/gcreport/index.html">http://www.hp.com/hpinfo/globalcitizenship/gcreport/index.html</a>  Eco-label certifications  <a href="http://www8.hp.com/us/en/hp-information/environment/ecolabels.html">http://www8.hp.com/us/en/hp-information/environment/ecolabels.html</a>  ISO 14001 certificates:  <a href="http://www.hp.com/hpinfo/globalcitizenship/environment/pdf/PC_GBU_Product_Design_ISO_14K_Certificate.pdf">http://www.hp.com/hpinfo/globalcitizenship/environment/pdf/PC_GBU_Product_Design_ISO_14K_Certificate.pdf</a>  and  <a href="http://www.hp.com/hpinfo/globalcitizenship/environment/pdf/cert.pdf">http://www.hp.com/hpinfo/globalcitizenship/environment/pdf/cert.pdf</a></p>

Standard Features and Configurable Components (availability may vary by country)

## HP ProDesk 400 G7 Microtower Series

<b>Eco-Label Certifications &amp; declarations</b>	<p>This product has received or is in the process of being certified to the following approvals and may be labeled with one or more of these marks:</p> <ul style="list-style-type: none"> <li>• IT ECO declaration</li> <li>• US ENERGY STAR® certified</li> <li>• EPEAT® 2019 registered where applicable. EPEAT® registration varies by country. See <a href="http://www.epeat.net">http://www.epeat.net</a> for registration status in your country*. Search keyword generator on HP's 3rd party option store for solar generator accessories at <a href="http://www.hp.com/go/options">http://www.hp.com/go/options</a>.</li> <li>• TCO Certified</li> </ul> <p>*Based on US EPEAT® registration according to IEEE 1680.1-2018 EPEAT®. Status varies by country. Visit <a href="http://www.epeat.net">http://www.epeat.net</a> for more information.</p>		
<b>System Configuration</b>	<p>The configuration used for the Energy Consumption and Declared Noise Emissions data for the Desktop model is based on a Typically Configured Desktop.</p>		
<b>Energy Consumption (in accordance with US ENERGY STAR® test method)</b>	<b>115VAC, 60Hz</b>	<b>230VAC, 50Hz</b>	<b>100VAC, 60Hz</b>
Normal Operation (Short idle)			
Normal Operation (Long idle)			
Sleep			
Off			
	<p><b>NOTE:</b> Energy efficiency data listed is for an ENERGY STAR® certified product if offered within the model family. HP computers marked with the ENERGY STAR® Logo are certified with the applicable U.S. Environmental Protection Agency (EPA) ENERGY STAR® specifications for computers. If a model family does not offer ENERGY STAR® certified configurations, then energy efficiency data listed is for a typically configured PC featuring a hard disk drive, a high efficiency power supply, and a Microsoft Windows® operating system.</p>		
<b>Heat Dissipation*</b>	<b>115VAC, 60Hz</b>	<b>230VAC, 50Hz</b>	<b>100VAC, 60Hz</b>
Normal Operation (Short idle)			
Normal Operation (Long idle)			
Sleep			
Off			
	<p><b>NOTE:</b> Heat dissipation is calculated based on the measured watts, assuming the service level is attained for one hour.</p>		
<b>Declared Noise Emissions (in accordance with ISO 7779 and ISO 9296)</b>	Sound Power (L <sub>WA</sub> d, bels)		Sound Pressure (L <sub>pAm</sub> , decibels)
Typically Configured – Idle			
Fixed Disk – Random writes			
Longevity and Upgrading	<p>This product can be upgraded, possibly extending its useful life by several years. Upgradeable features and/or components contained in the product may include:</p> <ul style="list-style-type: none"> <li>• 2 DIMM memory slots</li> <li>• Interchangeable M.2 PCIe NVME SSD &amp; 2.5"/3.5" SATA HDD</li> </ul>		

Standard Features and Configurable Components (availability may vary by country)

	Spare parts are available throughout the warranty period and or for up to “5” years after the end of production.	
Batteries	<p>This battery(s) in this product comply with EU Directive 2006/66/EC</p> <p>Batteries used in the product do not contain:                  Mercury greater than 1ppm by weight                  Cadmium greater than 20ppm by weight</p> <p>Battery size: CR2032 (coin cell)                  Battery type: Lithium</p>	
<b>Additional Information</b>	<ul style="list-style-type: none"> <li>• This product is in compliance with the Restrictions of Hazardous Substances (RoHS) directive - 2011/65/EC.</li> <li>• This HP product is designed to comply with the Waste Electrical and Electronic Equipment (WEEE) Directive – 2002/96/EC.</li> <li>• This product is in compliance with California Proposition 65 (State of California; Safe Drinking Water and Toxic Enforcement Act of 1986).</li> <li>• Plastics parts weighing over 25 grams used in the product are marked per ISO11469 and ISO1043.</li> <li>• This product contains a minimum of 35% post-consumer recycled (PCR) plastic (by wt.); including 10% ITE-derived post-consumer recycled plastic.*</li> <li>• This product is 95.1% recycle-able when properly disposed of at end of life.</li> </ul> <p>*Recycled plastic content percentage is based on the definition set in the IEEE 1680.1-2018 standard.</p>	
<b>Packaging Materials</b> (vary by country)	<b>External:</b>	PAPER/paperboard
		PAPER/Paper
	<b>Internal:</b>	PLASTIC/Polyethylene low density – LDPE
<b>Material Usage</b>	<p>This product does not contain any of the following substances in excess of regulatory limits (refer to the HP General Specification for the Environment at <a href="http://www.hp.com/hpinfo/globalcitizenship/environment/pdf/gse.pdf">http://www.hp.com/hpinfo/globalcitizenship/environment/pdf/gse.pdf</a>):</p> <ul style="list-style-type: none"> <li>• Asbestos</li> <li>• Certain Azo Colorants</li> <li>• Certain Brominated Flame Retardants – may not be used as flame retardants in plastics</li> <li>• Cadmium</li> <li>• Chlorinated Hydrocarbons</li> <li>• Chlorinated Paraffins</li> <li>• Formaldehyde</li> <li>• Halogenated Diphenyl Methanes</li> <li>• Lead carbonates and sulfates</li> <li>• Lead and Lead compounds</li> <li>• Mercuric Oxide Batteries</li> <li>• Nickel – finishes must not be used on the external surface designed to be frequently handled or carried by the user.</li> <li>• Ozone Depleting Substances</li> <li>• Polybrominated Biphenyls (PBBs)</li> <li>• Polybrominated Biphenyl Ethers (PBBEs)</li> <li>• Polybrominated Biphenyl Oxides (PBBOs)</li> <li>• Polychlorinated Biphenyl (PCB)</li> <li>• Polychlorinated Terphenyls (PCT)</li> <li>• Polyvinyl Chloride (PVC) – except for wires and cables, and certain retail packaging has been voluntarily removed from most applications.</li> <li>• Radioactive Substances</li> <li>• Tributyl Tin (TBT), Triphenyl Tin (TPT), Tributyl Tin Oxide (TBTO)</li> </ul>	

Standard Features and Configurable Components (availability may vary by country)

<p><b>Packaging Usage</b></p>	<p>HP follows these guidelines to decrease the environmental impact of product packaging:</p> <ul style="list-style-type: none"> <li>• Eliminate the use of heavy metals such as lead, chromium, mercury and cadmium in packaging materials.</li> <li>• Eliminate the use of ozone-depleting substances (ODS) in packaging materials.</li> <li>• Design packaging materials for ease of disassembly.</li> <li>• Maximize the use of post-consumer recycled content materials in packaging materials.</li> <li>• Use readily recyclable packaging materials such as paper and corrugated materials.</li> <li>• Reduce size and weight of packages to improve transportation fuel efficiency.</li> <li>• Plastic packaging materials are marked according to ISO 11469 and DIN 6120 standards.</li> </ul>
<p><b>End-of-life Management and Recycling</b></p>	<p>HP Inc. offers end-of-life HP product return and recycling programs in many geographic areas. To recycle your product, please go to: <a href="http://www.hp.com/go/reuse-recycle">http://www.hp.com/go/reuse-recycle</a> or contact your nearest HP sales office. Products returned to HP will be recycled, recovered or disposed of in a responsible manner.</p> <p>The EU WEEE directive (2002/95/EC) requires manufacturers to provide treatment information for each product type for use by treatment facilities. This information (product disassembly instructions) is posted on the Hewlett Packard web site at: <a href="http://www.hp.com/go/recyclers">http://www.hp.com/go/recyclers</a>. These instructions may be used by recyclers and other WEEE treatment facilities as well as HP OEM customers who integrate and re-sell HP equipment.</p> <p>Global Citizenship Report  <a href="http://www.hp.com/hpinfo/globalcitizenship/gcreport/index.html">http://www.hp.com/hpinfo/globalcitizenship/gcreport/index.html</a>          Eco-label certifications  <a href="http://www8.hp.com/us/en/hp-information/environment/ecolabels.html">http://www8.hp.com/us/en/hp-information/environment/ecolabels.html</a>          ISO 14001 certificates:  <a href="http://www.hp.com/hpinfo/globalcitizenship/environment/pdf/PC_GBU_Product_Design_ISO_14K_Certificate.pdf">http://www.hp.com/hpinfo/globalcitizenship/environment/pdf/PC_GBU_Product_Design_ISO_14K_Certificate.pdf</a>          and  <a href="http://www.hp.com/hpinfo/globalcitizenship/environment/pdf/cert.pdf">http://www.hp.com/hpinfo/globalcitizenship/environment/pdf/cert.pdf</a></p>

Standard Features and Configurable Components (availability may vary by country)

## HP ProOne 400 G6 24 All-in-One PC

<b>Eco-Label Certifications &amp; declarations</b>	<p>This product has received or is in the process of being certified to the following approvals and may be labeled with one or more of these marks:</p> <ul style="list-style-type: none"> <li>• IT ECO declaration</li> <li>• US ENERGY STAR® certified</li> <li>• EPEAT® 2019 registered where applicable. EPEAT® registration varies by country. See <a href="http://www.epeat.net">http://www.epeat.net</a> for registration status in your country*. Search keyword generator on HP's 3rd party option store for solar generator accessories at <a href="http://www.hp.com/go/options">http://www.hp.com/go/options</a>.</li> <li>• TCO Certified</li> </ul> <p>*Based on US EPEAT® registration according to IEEE 1680.1-2018 EPEAT®. Status varies by country. Visit <a href="http://www.epeat.net">http://www.epeat.net</a> for more information.</p>		
<b>System Configuration</b>	<p>The configuration used for the Energy Consumption and Declared Noise Emissions data for the Desktop model is based on a "Typically Configured Desktop".</p>		
<b>Energy Consumption (in accordance with US ENERGY STAR® test method)</b>	<b>115VAC, 60Hz</b>	<b>230VAC, 50Hz</b>	<b>100VAC, 60Hz</b>
Normal Operation (Short idle)	17.85 W	19.04 W	17.25 W
Normal Operation (Long idle)	5.63 W	6.47 W	4.51 W
Sleep	0.92 W	1.00 W	0.85 W
Off	0.73 W	0.74 W	0.64 W
	<p><b>NOTE:</b> Energy efficiency data listed is for an ENERGY STAR® certified product if offered within the model family. HP computers marked with the ENERGY STAR® Logo are certified with the applicable U.S. Environmental Protection Agency (EPA) ENERGY STAR® specifications for computers. If a model family does not offer ENERGY STAR® certified configurations, then energy efficiency data listed is for a typically configured PC featuring a hard disk drive, a high efficiency power supply, and a Microsoft Windows® operating system.</p>		
<b>Heat Dissipation*</b>	<b>115VAC, 60Hz</b>	<b>230VAC, 50Hz</b>	<b>100VAC, 60Hz</b>
Normal Operation (Short idle)	60.8685 BTU/hr	64.9264 BTU/hr	58.8225 BTU/hr
Normal Operation (Long idle)	19.1983 BTU/hr	22.0627 BTU/hr	15.3791 BTU/hr
Sleep	3.1372 BTU/hr	3.41 BTU/hr	2.8985 BTU/hr
Off	2.4893 BTU/hr	2.5234 BTU/hr	2.1824 BTU/hr
	<p><b>NOTE:</b> Heat dissipation is calculated based on the measured watts, assuming the service level is attained for one hour.</p>		
<b>Declared Noise Emissions (in accordance with ISO 7779 and ISO 9296)</b>	Sound Power (L <sub>WAd</sub> , bels)		Sound Pressure (L <sub>pAm</sub> , decibels)
Typically Configured – Idle	2.8		17.6
Fixed Disk – Random writes	3.1		21.2
Longevity and Upgrading	<p>This product can be upgraded, possibly extending its useful life by several years. Upgradeable features and/or components contained in the product may include:</p> <ul style="list-style-type: none"> <li>• 2 SODIMM memory slots</li> <li>• Interchangeable M.2 PCIe NVME SSD &amp; 2.5" SATA HDD</li> </ul>		

Standard Features and Configurable Components (availability may vary by country)

	Spare parts are available throughout the warranty period and or for up to “5” years after the end of production.	
Batteries	<p>This battery(s) in this product comply with EU Directive 2006/66/EC</p> <p>Batteries used in the product do not contain:                  Mercury greater than 1ppm by weight                  Cadmium greater than 20ppm by weight</p> <p>Battery size: CR2032 (coin cell)                  Battery type: Lithium</p>	
<b>Additional Information</b>	<ul style="list-style-type: none"> <li>• This product is in compliance with the Restrictions of Hazardous Substances (RoHS) directive - 2011/65/EC.</li> <li>• This HP product is designed to comply with the Waste Electrical and Electronic Equipment (WEEE) Directive – 2002/96/EC.</li> <li>• This product is in compliance with California Proposition 65 (State of California; Safe Drinking Water and Toxic Enforcement Act of 1986).</li> <li>• Plastics parts weighing over 25 grams used in the product are marked per ISO11469 and ISO1043.</li> <li>• This product contains a minimum of 50% post-consumer recycled (PCR) plastic (by wt.); including 10% ITE-derived post-consumer recycled plastic.*</li> <li>• This product is 95.1% recycle-able when properly disposed of at end of life.</li> </ul> <p>*Recycled plastic content percentage is based on the definition set in the IEEE 1680.1-2018 standard.</p>	
<b>Packaging Materials</b> (vary by country)	<b>External:</b>	PAPER/Corrugated
	<b>Internal:</b>	PLASTIC/Polyethylene Expanded - EPE
		PLASTIC/Polyethylene low density - LDPE
	1605 g	683 g
		42 g
<b>Material Usage</b>	<p>This product does not contain any of the following substances in excess of regulatory limits (refer to the HP General Specification for the Environment at <a href="http://www.hp.com/hpinfo/globalcitizenship/environment/pdf/gse.pdf">http://www.hp.com/hpinfo/globalcitizenship/environment/pdf/gse.pdf</a>):</p> <ul style="list-style-type: none"> <li>• Asbestos</li> <li>• Certain Azo Colorants</li> <li>• Certain Brominated Flame Retardants – may not be used as flame retardants in plastics</li> <li>• Cadmium</li> <li>• Chlorinated Hydrocarbons</li> <li>• Chlorinated Paraffins</li> <li>• Formaldehyde</li> <li>• Halogenated Diphenyl Methanes</li> <li>• Lead carbonates and sulfates</li> <li>• Lead and Lead compounds</li> <li>• Mercuric Oxide Batteries</li> <li>• Nickel – finishes must not be used on the external surface designed to be frequently handled or carried by the user.</li> <li>• Ozone Depleting Substances</li> <li>• Polybrominated Biphenyls (PBBs)</li> <li>• Polybrominated Biphenyl Ethers (PBBEs)</li> <li>• Polybrominated Biphenyl Oxides (PBBOs)</li> <li>• Polychlorinated Biphenyl (PCB)</li> <li>• Polychlorinated Terphenyls (PCT)</li> <li>• Polyvinyl Chloride (PVC) – except for wires and cables, and certain retail packaging has been voluntarily removed from most applications.</li> <li>• Radioactive Substances</li> <li>• Tributyl Tin (TBT), Triphenyl Tin (TPT), Tributyl Tin Oxide (TBTO)</li> </ul>	



Standard Features and Configurable Components (availability may vary by country)

<p><b>Packaging Usage</b></p>	<p>HP follows these guidelines to decrease the environmental impact of product packaging:</p> <ul style="list-style-type: none"> <li>• Eliminate the use of heavy metals such as lead, chromium, mercury and cadmium in packaging materials.</li> <li>• Eliminate the use of ozone-depleting substances (ODS) in packaging materials.</li> <li>• Design packaging materials for ease of disassembly.</li> <li>• Maximize the use of post-consumer recycled content materials in packaging materials.</li> <li>• Use readily recyclable packaging materials such as paper and corrugated materials.</li> <li>• Reduce size and weight of packages to improve transportation fuel efficiency.</li> <li>• Plastic packaging materials are marked according to ISO 11469 and DIN 6120 standards.</li> </ul>
<p><b>End-of-life Management and Recycling</b></p>	<p>HP Inc. offers end-of-life HP product return and recycling programs in many geographic areas. To recycle your product, please go to: <a href="http://www.hp.com/go/reuse-recycle">http://www.hp.com/go/reuse-recycle</a> or contact your nearest HP sales office. Products returned to HP will be recycled, recovered or disposed of in a responsible manner.</p> <p>The EU WEEE directive (2002/95/EC) requires manufacturers to provide treatment information for each product type for use by treatment facilities. This information (product disassembly instructions) is posted on the Hewlett Packard web site at: <a href="http://www.hp.com/go/recyclers">http://www.hp.com/go/recyclers</a>. These instructions may be used by recyclers and other WEEE treatment facilities as well as HP OEM customers who integrate and re-sell HP equipment.</p> <p>Global Citizenship Report  <a href="http://www.hp.com/hpinfo/globalcitizenship/gcreport/index.html">http://www.hp.com/hpinfo/globalcitizenship/gcreport/index.html</a>          Eco-label certifications  <a href="http://www8.hp.com/us/en/hp-information/environment/ecolabels.html">http://www8.hp.com/us/en/hp-information/environment/ecolabels.html</a>          ISO 14001 certificates:  <a href="http://www.hp.com/hpinfo/globalcitizenship/environment/pdf/PC_GBU_Product_Design_ISO_14K_Certificate.pdf">http://www.hp.com/hpinfo/globalcitizenship/environment/pdf/PC_GBU_Product_Design_ISO_14K_Certificate.pdf</a>          and  <a href="http://www.hp.com/hpinfo/globalcitizenship/environment/pdf/cert.pdf">http://www.hp.com/hpinfo/globalcitizenship/environment/pdf/cert.pdf</a></p>

Standard Features and Configurable Components (availability may vary by country)

## HP ProOne 400 G6 20 All-in-One PC

<b>Eco-Label Certifications &amp; declarations</b>	<p>This product has received or is in the process of being certified to the following approvals and may be labeled with one or more of these marks:</p> <ul style="list-style-type: none"> <li>• IT ECO declaration</li> <li>• US ENERGY STAR® certified</li> <li>• EPEAT® 2019 registered where applicable. EPEAT® registration varies by country. See <a href="http://www.epeat.net">http://www.epeat.net</a> for registration status in your country*. Search keyword generator on HP's 3rd party option store for solar generator accessories at <a href="http://www.hp.com/go/options">http://www.hp.com/go/options</a>.</li> <li>• TCO Certified</li> </ul> <p>*Based on US EPEAT® registration according to IEEE 1680.1-2018 EPEAT®. Status varies by country. Visit <a href="http://www.epeat.net">http://www.epeat.net</a> for more information.</p>		
<b>System Configuration</b>	<p>The configuration used for the Energy Consumption and Declared Noise Emissions data for the Desktop model is based on a "Typically Configured Desktop".</p>		
<b>Energy Consumption (in accordance with US ENERGY STAR® test method)</b>	<b>115VAC, 60Hz</b>	<b>230VAC, 50Hz</b>	<b>100VAC, 60Hz</b>
Normal Operation (Short idle)	14.62 W	15.84 W	14.12 W
Normal Operation (Long idle)	5.41 W	6.23 W	4.25 W
Sleep	0.91 W	0.98 W	0.83 W
Off	0.71 W	0.73 W	0.65 W
	<p><b>NOTE:</b> Energy efficiency data listed is for an ENERGY STAR® certified product if offered within the model family. HP computers marked with the ENERGY STAR® Logo are certified with the applicable U.S. Environmental Protection Agency (EPA) ENERGY STAR® specifications for computers. If a model family does not offer ENERGY STAR® certified configurations, then energy efficiency data listed is for a typically configured PC featuring a hard disk drive, a high efficiency power supply, and a Microsoft Windows® operating system.</p>		
<b>Heat Dissipation*</b>	<b>115VAC, 60Hz</b>	<b>230VAC, 50Hz</b>	<b>100VAC, 60Hz</b>
Normal Operation (Short idle)	49.8542 BTU/hr	51.0144 BTU/hr	48.1492 BTU/hr
Normal Operation (Long idle)	18.4481 BTU/hr	21.2443 BTU/hr	14.4925 BTU/hr
Sleep	3.0690 BTU/hr	3.3418 BTU/hr	2.8303 BTU/hr
Off	2.4211 BTU/hr	2.4893 BTU/hr	2.2165 BTU/hr
	<p><b>NOTE:</b> Heat dissipation is calculated based on the measured watts, assuming the service level is attained for one hour.</p>		
<b>Declared Noise Emissions (in accordance with ISO 7779 and ISO 9296)</b>	Sound Power (L <sub>WAd</sub> , bels)		Sound Pressure (L <sub>pAm</sub> , decibels)
Typically Configured – Idle	2.8		16.5
Fixed Disk – Random writes	3		19.5
Longevity and Upgrading	<p>This product can be upgraded, possibly extending its useful life by several years. Upgradeable features and/or components contained in the product may include:</p> <ul style="list-style-type: none"> <li>• 2 SODIMM memory slots</li> <li>• Interchangeable M.2 PCIe NVME SSD &amp; 2.5" SATA HDD</li> </ul> <p>Spare parts are available throughout the warranty period and or for up to "5" years after the end of production.</p>		

Standard Features and Configurable Components (availability may vary by country)

<p><b>Batteries</b></p>	<p>This battery(s) in this product comply with EU Directive 2006/66/EC</p> <p>Batteries used in the product do not contain:                  Mercury greater than 1ppm by weight                  Cadmium greater than 20ppm by weight</p> <p>Battery size: CR2032 (coin cell)                  Battery type: Lithium</p>		
<p><b>Additional Information</b></p>	<ul style="list-style-type: none"> <li>• This product is in compliance with the Restrictions of Hazardous Substances (RoHS) directive - 2011/65/EC.</li> <li>• This HP product is designed to comply with the Waste Electrical and Electronic Equipment (WEEE) Directive – 2002/96/EC.</li> <li>• This product is in compliance with California Proposition 65 (State of California; Safe Drinking Water and Toxic Enforcement Act of 1986).</li> <li>• Plastics parts weighing over 25 grams used in the product are marked per ISO11469 and ISO1043.</li> <li>• This product contains a minimum of 50% post-consumer recycled (PCR) plastic (by wt.); including 10% ITE-derived post-consumer recycled plastic.*</li> <li>• This product is 95.1% recycle-able when properly disposed of at end of life.</li> </ul> <p>*Recycled plastic content percentage is based on the definition set in the IEEE 1680.1-2018 standard.</p>		
<p><b>Packaging Materials</b> (vary by country)</p>	<p><b>External:</b></p>	<p>PAPER/Corrugated</p>	<p>1446 g</p>
	<p><b>Internal:</b></p>	<p>PLASTIC/Polyethylene Expanded - EPE</p>	<p>447 g</p>
		<p>PLASTIC/Polyethylene low density - LDPE</p>	<p>36 g</p>
<p><b>Material Usage</b></p>	<p>This product does not contain any of the following substances in excess of regulatory limits (refer to the HP General Specification for the Environment at <a href="http://www.hp.com/hpinfo/globalcitizenship/environment/pdf/gse.pdf">http://www.hp.com/hpinfo/globalcitizenship/environment/pdf/gse.pdf</a>):</p> <ul style="list-style-type: none"> <li>• Asbestos</li> <li>• Certain Azo Colorants</li> <li>• Certain Brominated Flame Retardants – may not be used as flame retardants in plastics</li> <li>• Cadmium</li> <li>• Chlorinated Hydrocarbons</li> <li>• Chlorinated Paraffins</li> <li>• Formaldehyde</li> <li>• Halogenated Diphenyl Methanes</li> <li>• Lead carbonates and sulfates</li> <li>• Lead and Lead compounds</li> <li>• Mercuric Oxide Batteries</li> <li>• Nickel – finishes must not be used on the external surface designed to be frequently handled or carried by the user.</li> <li>• Ozone Depleting Substances</li> <li>• Polybrominated Biphenyls (PBBs)</li> <li>• Polybrominated Biphenyl Ethers (PBBEs)</li> <li>• Polybrominated Biphenyl Oxides (PBBOs)</li> <li>• Polychlorinated Biphenyl (PCB)</li> <li>• Polychlorinated Terphenyls (PCT)</li> <li>• Polyvinyl Chloride (PVC) – except for wires and cables, and certain retail packaging has been voluntarily removed from most applications.</li> <li>• Radioactive Substances</li> <li>• Tributyl Tin (TBT), Triphenyl Tin (TPT), Tributyl Tin Oxide (TBTO)</li> </ul>		

Standard Features and Configurable Components (availability may vary by country)

<p><b>Packaging Usage</b></p>	<p>HP follows these guidelines to decrease the environmental impact of product packaging:</p> <ul style="list-style-type: none"> <li>• Eliminate the use of heavy metals such as lead, chromium, mercury and cadmium in packaging materials.</li> <li>• Eliminate the use of ozone-depleting substances (ODS) in packaging materials.</li> <li>• Design packaging materials for ease of disassembly.</li> <li>• Maximize the use of post-consumer recycled content materials in packaging materials.</li> <li>• Use readily recyclable packaging materials such as paper and corrugated materials.</li> <li>• Reduce size and weight of packages to improve transportation fuel efficiency.</li> <li>• Plastic packaging materials are marked according to ISO 11469 and DIN 6120 standards.</li> </ul>
<p><b>End-of-life Management and Recycling</b></p>	<p>HP Inc. offers end-of-life HP product return and recycling programs in many geographic areas. To recycle your product, please go to: <a href="http://www.hp.com/go/reuse-recycle">http://www.hp.com/go/reuse-recycle</a> or contact your nearest HP sales office. Products returned to HP will be recycled, recovered or disposed of in a responsible manner.</p> <p>The EU WEEE directive (2002/95/EC) requires manufacturers to provide treatment information for each product type for use by treatment facilities. This information (product disassembly instructions) is posted on the Hewlett Packard web site at: <a href="http://www.hp.com/go/recyclers">http://www.hp.com/go/recyclers</a>. These instructions may be used by recyclers and other WEEE treatment facilities as well as HP OEM customers who integrate and re-sell HP equipment.</p>
<p><b>HP Inc. Corporate Environmental Information</b></p>	<p>For more information about HP's commitment to the environment:</p> <p>Global Citizenship Report  <a href="http://www.hp.com/hpinfo/globalcitizenship/gcreport/index.html">http://www.hp.com/hpinfo/globalcitizenship/gcreport/index.html</a>          Eco-label certifications  <a href="http://www8.hp.com/us/en/hp-information/environment/ecolabels.html">http://www8.hp.com/us/en/hp-information/environment/ecolabels.html</a>          ISO 14001 certificates:  <a href="http://www.hp.com/hpinfo/globalcitizenship/environment/pdf/PC_GBU_Product_Design_ISO_14K_Certificate.pdf">http://www.hp.com/hpinfo/globalcitizenship/environment/pdf/PC_GBU_Product_Design_ISO_14K_Certificate.pdf</a>          and  <a href="http://www.hp.com/hpinfo/globalcitizenship/environment/pdf/cert.pdf">http://www.hp.com/hpinfo/globalcitizenship/environment/pdf/cert.pdf</a></p>

## SERVICE AND SUPPORT

On-site Warranty<sup>1</sup>: Three-year (3-3-3) or one-year (1-1-1) limited warranty delivers three years or one year of on-site, next business day<sup>2</sup> service for parts and labor and includes free support 24 x 7<sup>3</sup>. Three-year onsite and labor are not available in all countries. Service offers terms up to 5 years by choosing an optional HP Care Pack. To choose the right level of service for your HP product, visit HP Care Pack Central: <http://www.hp.com/go/cpc>.<sup>4</sup>

1. Terms and conditions may vary by country. Certain restrictions and exclusions apply. Other warranty variations may be offered in your region.
2. On-site service may be provided pursuant to a service contract between HP and an authorized HP third-party provider, and is not available in certain countries. Global service response times are based on commercially reasonable best effort and may vary by country.
3. Technical telephone support applies only to HP-configured and third-party HP qualified hardware and software. Toll-free calling and 24 x 7 support may not be available in some countries.
4. Service levels and response times for HP Care Packs may vary depending on your geographic location. Service starts on date of hardware purchase. Restrictions and limitations apply. For details, visit [www.hp.com/go/cpc](http://www.hp.com/go/cpc). HP services are governed by the applicable HP terms and conditions of service provided or indicated to Customer at the time of purchase. Customer may have additional statutory rights according to applicable local laws, and such rights are not in any way affected by the HP terms and conditions of service or the HP Limited Warranty provided with your HP Product.

## Technical Specifications - Processors

### PROCESSORS

#### Intel® 10<sup>th</sup> Generation Core™ Processors

All HP ProDesk & ProOne 400 Business PC models featuring this technology include processors that are part of the Intel® Stable Image Platform Program (SIPP) designed to ensure the stability promise inherent in the value proposition of the HP ProDesk and ProOne 400 Business PC.

Intel® Advanced Management Technology (AMT) v12<sup>1</sup> – An advanced set of remote management features and functionality which provides network administrators the latest and most effective tools to remotely discover, heal, and protect networked client systems regardless of the system's health or power state. AMT 12 includes the following advanced management functions:

- Support for configuration of Intel AMT 12.0 capabilities
- No reset after provisioning
- Support for Intel Enterprise Digital Fence
- The Platform Discovery Utility can now discover these additional Intel products:
  - Intel Identity Protection Technology with One Time Password
  - Public Key Infrastructure
  - Multi Factor Authentication
- Profile Editor and Profile Editor Plugin Interface
- Required Permissions for Solutions Framework

1. Intel® Active Management Technology requires an Intel® AMT-enabled chipset, network hardware and software, as well as connection with a power source and a corporate network connection. Setup requires configuration by the purchaser and may require scripting with the management console or further integration into existing security frameworks to enable certain functionality. It may also require modifications of implementation of new business processes.

## Technical Specifications – Display Panel Specifications

**DISPLAY PANEL SPECIFICATIONS<sup>1</sup>****HP ProOne 400 G6 All in-One PC****23.8" diagonal IPS widescreen WLED backlit anti-glare LCD (1920 x 1080)**

Non-touch or optional touch

Projected Capacitive Touch supports up to 10 touch-points

<b>Type</b>	IPS WLED Backlit LCD
<b>Active area (mm)</b>	527.04 x 296.46
<b>Native Resolution (HxV)</b>	1920 x 1080
<b>Refresh Rate</b>	60 Hz @ 1920 x 1080
<b>Aspect ratio</b>	16:9
<b>Pixel pitch (HxV)(mm)</b>	0.2745 x 0.2745
<b>Contrast ratio (typical)</b>	1000:1
<b>Brightness (typical)</b>	250nits
<b>Viewing angle (typical) (HxV)</b>	178° x 178°
<b>Backlight lamp life (to half brightness)</b>	30,000 hours minimum
<b>Color support</b>	Up to 16.7 million colors with the use of FRC technology
<b>Color gamut (typical)</b>	NTSC 72%
<b>Anti-glare</b>	Yes
<b>Response Time</b>	14ms (typical)
<b>Default color temperature</b>	Warm (6500K)
<b>Hardware based low blue light</b>	Available on non-touch variant

**19.53" diagonal widescreen WLED backlit anti-glare LCD (1920 x 1080) Non-touch**

<b>Type</b>	VA WLED Backlit LCD
<b>Active area (mm)</b>	434.88 x 238.68
<b>Native Resolution (HxV)</b>	1920 x 1080
<b>Refresh Rate</b>	60 Hz @ 1920 x 1080
<b>Aspect ratio</b>	16:9
<b>Pixel pitch (HxV)(mm)</b>	0.2265 x 0.221
<b>Contrast ratio (typical)</b>	3000:1
<b>Brightness (typical)</b>	250nits
<b>Viewing angle (typical) (HxV)</b>	178° x 178°
<b>Backlight lamp life (to half brightness)</b>	30,000 hours minimum
<b>Color support</b>	Up to 16.7 million colors
<b>Color gamut (typical)</b>	NTSC 72%
<b>Anti-glare</b>	Yes
<b>Response Time</b>	25ms (typical)
<b>Default color temperature</b>	Warm (6500K)

1. All specifications represent the typical specifications provided by HP's component manufacturers; actual performance may vary either higher or lower.

## Technical Specifications – All-in-One Stand Specifications

### ALL-IN-ONE STAND SPECIFICATIONS

#### HP ProOne 400 G6 24 All-in-One PC

**Cantilever Stand (Fixed  
Height Tilt Stand)**

**Tilt Angle**  
**Rotation (Swivel)**  
**Pivot**

-5° to +20°  
None  
None

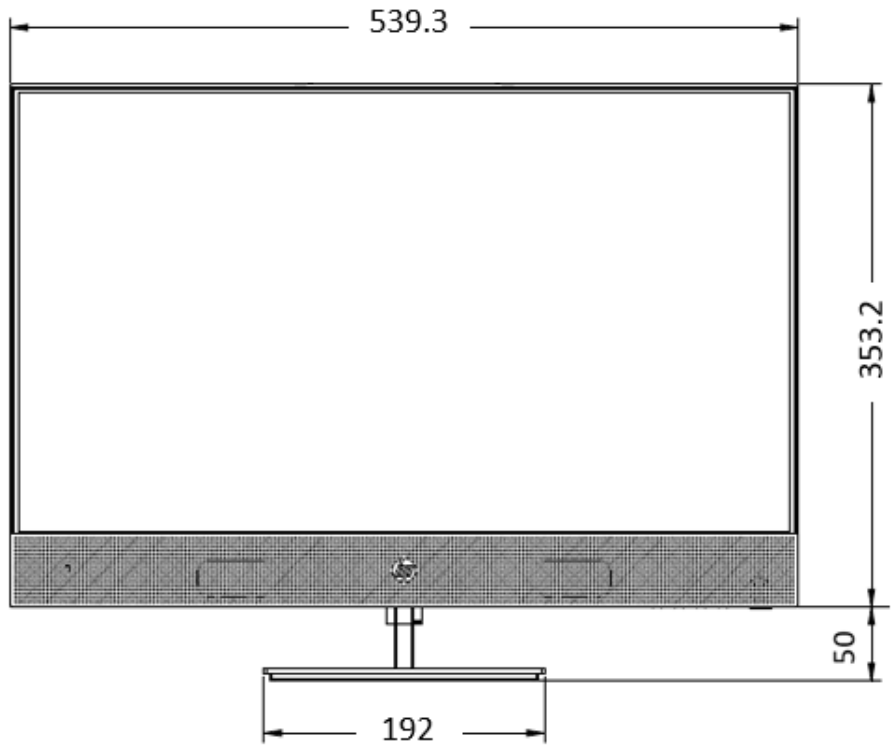
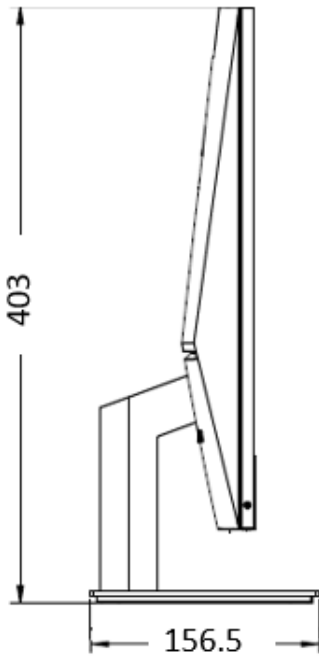

## Technical Specifications – All-in-One Stand Specifications

<b>Adjustable Height Stand</b>	<b>Height Adjustment (Landscape Mode)</b>	5.12 in / 130mm
	<b>Height Adjustment (Portrait Mode)</b>	N/A
	<b>Tilt Angle</b>	-5° to +20°
	<b>Rotation (Swivel)</b>	±45°
	<b>Pivot</b>	None

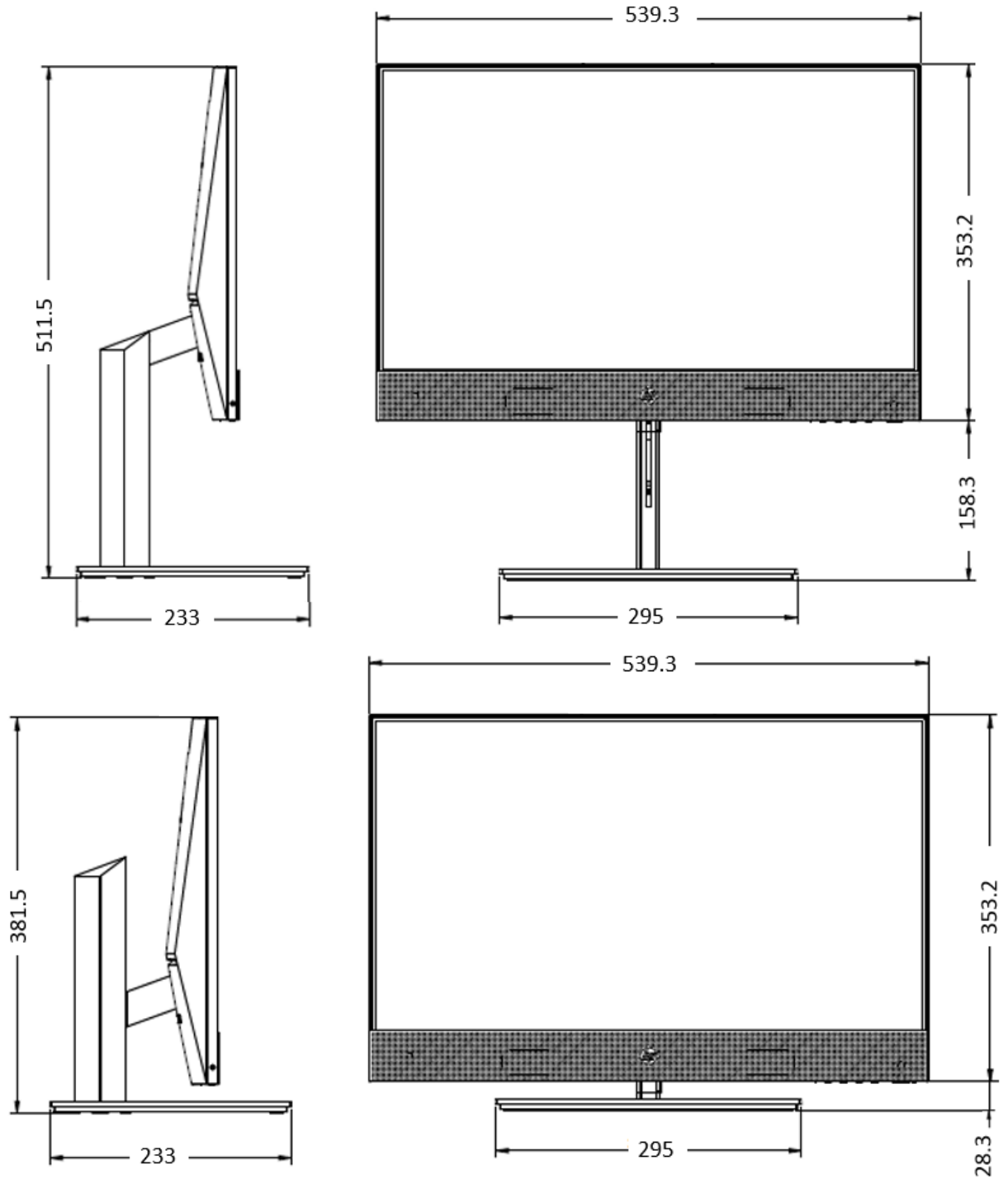



## Technical Specifications – All-in-One Stand Specifications

### HP ProOne 400 G6 20 All-in-One PC

<b>Cantilever Stand (Fixed)</b>	<b>Tilt Angle</b>	-5° to +20°
<b>Height Tilt Stand)</b>	<b>Rotation (Swivel)</b>	None
	<b>Pivot</b>	None

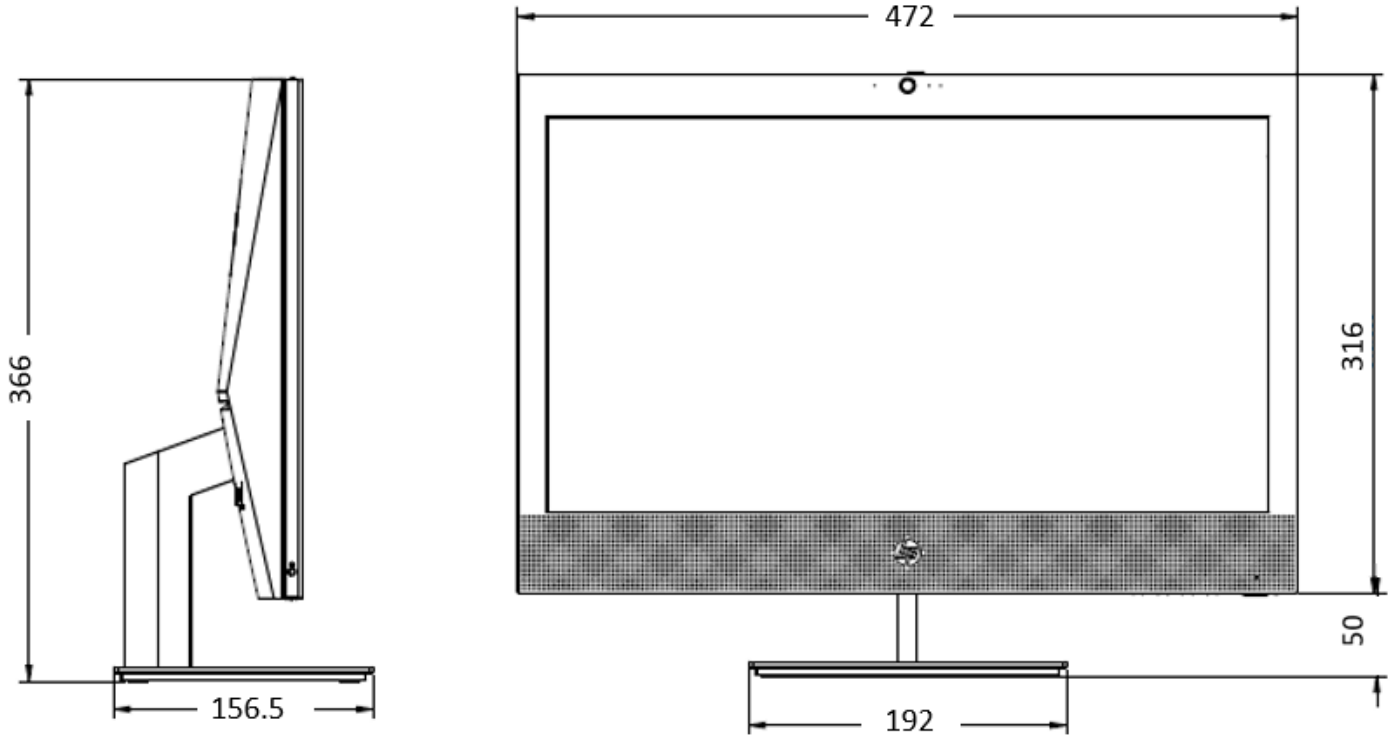

## Technical Specifications – All-in-One Stand Specifications

<b>Adjustable Height Stand</b>	<b>Height Adjustment (Landscape Mode)</b>	5.12 in / 130 mm
	<b>Height Adjustment (Portrait Mode)</b>	N/A
	<b>Tilt Angle</b>	-5° to +20°
	<b>Rotation (Swivel)</b>	±45°
	<b>Pivot</b>	None

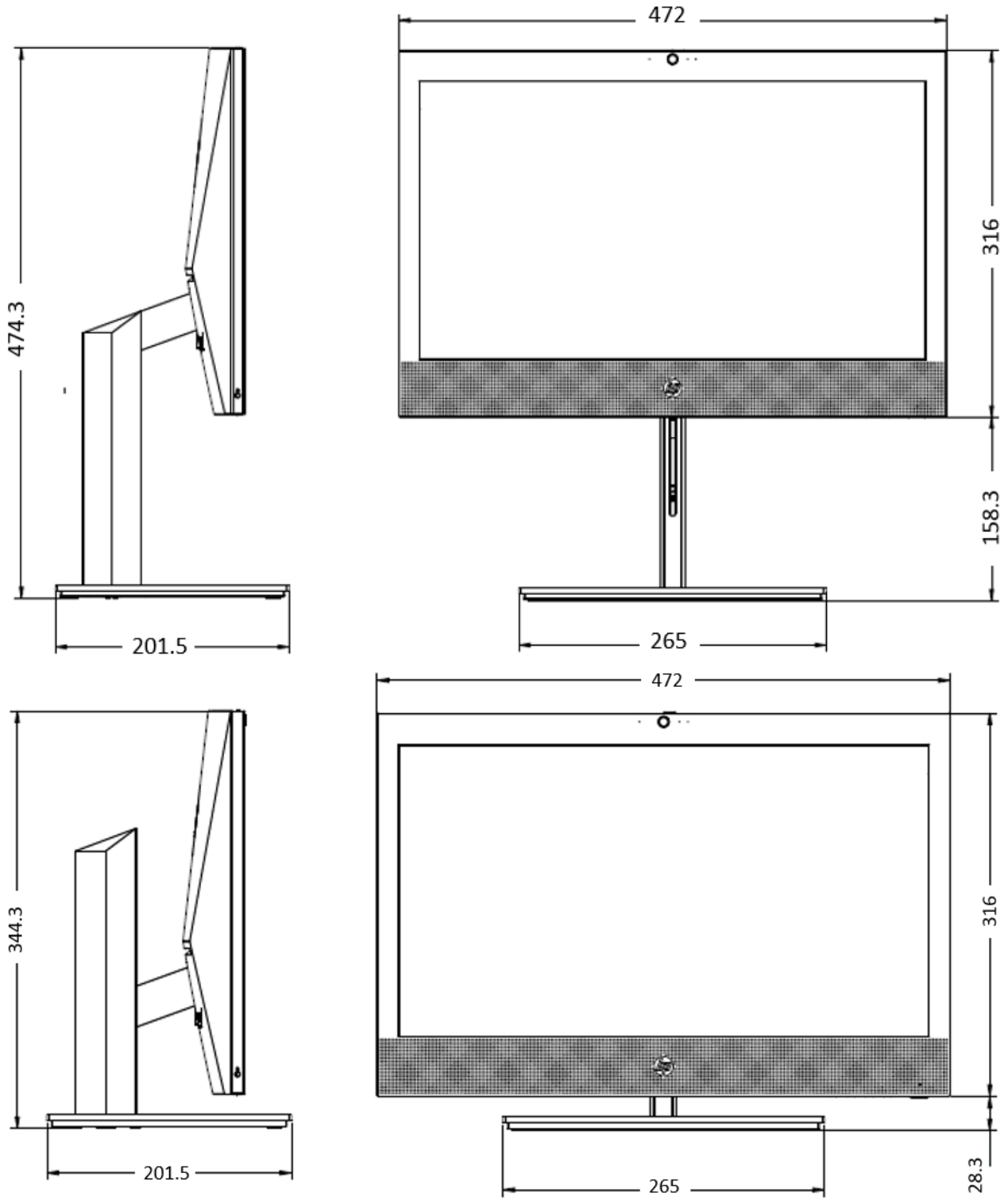

## Technical Specifications – Graphics

### GRAPHICS

#### Intel® UHD Graphics (integrated)

<b>Graphics Controller</b>	Integrated
<b>DisplayPort™</b>	Multimode capable; supports HDCP, Display Port Audio (2 streams), HBR2 link rates and Multi-Stream Technology for a maximum of 3 displays connected to any output controlled by Intel® Graphics
<b>HDMI</b>	Supports HDMI 2.0a features Supports HDCP 2.2 Supports audio over HDMI
<b>VGA</b>	VGA output
<b>USB-C™ DP Alt Mode</b>	DisplayPort™ over the USB-C™ module
<b>Memory</b>	The actual amount of maximum graphics memory can be >4GB. System memory is allocated for graphics as needed using Intel's Dynamic Video Memory Technology (DVM), to provide an optimal balance between graphics and system memory use.
<b>Maximum Color Depth</b>	up to 10 bits/color HEVC 10b Enc/Dec HW VP9 10b Dec HW
<b>Graphics/Video API Support</b>	HDR Rec. 2020 DX12
<b>Max. Resolution (VGA)</b>	2048 x 1536@60Hz
<b>Max. Resolution (HDMI)</b>	4096 x 2160@60Hz
<b>Max. Resolution (DP)</b>	4096 x 2160@60Hz

#### AMD® Radeon™ RX 550X 4 GB FH 2DP+HDMI

<b>Engine Clock</b>	1183MHz
<b>Memory Clock</b>	6 Gbps
<b>Memory Size(width)</b>	4 GB(128-bit)
<b>Memory Type</b>	GDDR5
<b>Max. Resolution(HDMI)</b>	4096x2160 @ 60Hz
<b>Max. Resolution(DP)</b>	5120x2880 @ 60Hz
<b>Multi Display Support</b>	2 displays
<b>HDCP Compliance</b>	Yes
<b>Rear I/O connectors(bracket)</b>	HDMI, DP
<b>Cooling(active/passive)</b>	Active fan-sink (Active cooling with dynamic speed)
<b>Total power consumption(W)</b>	<50W
<b>PCB form-factor with bracket</b>	LP (low profile) PCB with FH/LP bracket

#### AMD® Radeon™ R7 430 2GB VGA+DP 64bit Graphics Card

<b>Engine Clock</b>	780 MHz
<b>Memory Clock</b>	1100 MHz
<b>Memory Size(width)</b>	2 GB(64-bit)
<b>Memory Type</b>	256M x 32 GDDR5
<b>Max. Resolution(HDMI)</b>	2048x1536
<b>Max. Resolution(DP)</b>	4096x2160@60Hz



## Technical Specifications – Graphics

<b>Multi Display Support</b>	2 displays
<b>HDCP Compliance</b>	Yes
<b>Rear I/O connectors(bracket)</b>	VGA+DP
<b>Cooling(active/passive)</b>	Active fan-sink (Active cooling with dynamic speed)
<b>Total power consumption(W)</b>	<50W
<b>PCB form-factor with bracket</b>	LP PCB with FH/LP bracket

### AMD® Radeon™ R7 430 2GB GDDR5 2DP 64 bit Graphics Card

<b>Engine Clock</b>	780 MHz
<b>Memory Clock</b>	1100 MHz
<b>Memory Size(width)</b>	2 GB(64-bit)
<b>Memory Type</b>	256M x 32 GDDR5
<b>Max. Resolution(DP)</b>	4096x2160@60Hz
<b>Multi Display Support</b>	2 displays
<b>HDCP Compliance</b>	yes
<b>Rear I/O connectors(bracket)</b>	DPx2
<b>Cooling(active/passive)</b>	Active fan-sink (Active cooling with dynamic speed)
<b>Total power consumption(W)</b>	<50W
<b>PCB form-factor with bracket</b>	LP PCB with FH/LP bracket

### AMD Radeon™ 630 with 2 GB GDDR5

<b>Memory</b>	2 GB 64-bit wide frame buffer operating at 1125MHz.
<b>Controller Clock Speed</b>	AMD Radeon™ 630 GPU operating at 1024 MHz
<b>Architecture</b>	Hybrid Graphics AMD GPU uses Intel® graphics controller for display control
<b>Bus Connection</b>	PCIe 3.0 x8
<b>Graphics /API support</b>	DIRECTX 12, Open GL 4.5, Open CL2.0, UVD, , Mantle, AMD LiquidVR™
<b>Display support</b>	Same as for the Intel® integrated graphics solution
<b>Max. Resolution (HDMI)</b>	4096 X 2160@60Hz
<b>Max. Resolution (DP)</b>	4096 X 2160@60Hz

### AMD Radeon™ 520 1GB Graphics Card

<b>Engine Clock</b>	780 MHz
<b>Memory Clock</b>	1150 MHz
<b>Memory Size(width)</b>	1 GB (32-bit)
<b>Memory Type</b>	256M x 32 GDDR5
<b>Max. Resolution(DP)</b>	2048x1536@60Hz
<b>Multi Display Support</b>	2 displays
<b>HDCP Compliance</b>	Yes
<b>Rear I/O connectors(bracket)</b>	VGA+DP
<b>Cooling(active/passive)</b>	Active fan-sink (Active cooling with dynamic speed)
<b>Total power consumption(W)</b>	<50W
<b>PCB form-factor with bracket</b>	PCB with FH bracket

## Technical Specifications – Storage

### STORAGE

#### 500GB 7200RPM 3.5in SATA HDD

<b>Capacity</b>	500 GB
<b>Rotational Speed</b>	7,200 rpm
<b>Interface</b>	SATA 6.0 Gb/s
<b>Buffer Size</b>	32 MB
<b>Logical Blocks</b>	976,773,168
<b>Seek Time</b>	11 ms (Average)
<b>Height</b>	1 in/2.54 cm
<b>Width</b>	Media diameter: 3.5 in/8.89 cm Physical size: 4 in/10.2 cm
<b>Operating Temperature</b>	41° to 131° F (5° to 55° C)

**NOTE:** For hard drives and solid state drives, GB = 1 billion bytes. TB = 1 trillion bytes. Actual formatted capacity is less. Up to 36 GB (for Windows 10) of system disk is reserved for the system recovery software.

#### 1TB 7200RPM 3.5in SATA HDD

<b>Capacity</b>	1 TB
<b>Rotational Speed</b>	7,200 rpm
<b>Interface</b>	SATA 6 Gb/s
<b>Buffer Size</b>	64 MB
<b>Logical Blocks</b>	1,953,525,168
<b>Seek Time</b>	11 ms (Average)
<b>Height</b>	1 in/2.54 cm
<b>Width (nominal)</b>	Media diameter: 3.5 in/8.89 cm Physical size: 4 in/10.2 cm
<b>Operating Temperature</b>	41° to 131° F (5° to 55° C)

**NOTE:** For hard drives and solid state drives, GB = 1 billion bytes. TB = 1 trillion bytes. Actual formatted capacity is less. Up to 36 GB (for Windows 10) of system disk is reserved for the system recovery software.

#### 2TB 7200RPM 3.5in SATA HDD

<b>Capacity</b>	2 TB
<b>Rotational Speed</b>	7,200 rpm
<b>Interface</b>	SATA 6 Gb/s
<b>Buffer Size</b>	64 MB
<b>Logical Blocks</b>	3,907,029,168
<b>Seek Time</b>	11 ms (Average)
<b>Height</b>	1.028 in/26.11 mm
<b>Width (nominal)</b>	Media diameter: 3.5 in/8.89 cm Physical size: 4 in/10.2 cm
<b>Operating Temperature</b>	41° to 131° F (5° to 55° C)

**NOTE:** For hard drives and solid state drives, GB = 1 billion bytes. TB = 1 trillion bytes. Actual formatted capacity is less. Up to 36 GB (for Windows 10) of system disk is reserved for the system recovery software.

## Technical Specifications – Storage

### 500GB 7200RPM 2.5in SATA HDD

<b>Capacity</b>	500 GB
<b>Rotational Speed</b>	7,200 rpm
<b>Interface</b>	SATA 6 Gb/s
<b>Buffer Size</b>	Up to 128 MB
<b>Logical Blocks</b>	976,773,168
<b>Seek Time</b>	12 ms (Average)
<b>Height</b>	0.283 in/7.2 mm (Max)
<b>Width (nominal)</b>	2.75 in/70 mm (nominal)
<b>Operating Temperature</b>	41° to 131° F (5° to 55° C)

**NOTE:** For hard drives and solid state drives, GB = 1 billion bytes. TB = 1 trillion bytes. Actual formatted capacity is less. Up to 36 GB (for Windows 10) of system disk is reserved for the system recovery software.

### 1TB 7200RPM 2.5in SATA HDD

<b>Capacity</b>	1 TB
<b>Rotational Speed</b>	7,200 rpm
<b>Interface</b>	SATA 6 Gb/s
<b>Buffer Size</b>	Up to 128 MB
<b>Logical Blocks</b>	1,953,525,168
<b>Seek Time</b>	12 ms (Average)
<b>Height</b>	0.374 in/9.5 mm (Max.)
<b>Width (nominal)</b>	2.75 in/70 mm (nominal)
<b>Operating Temperature</b>	41° to 131° F (5° to 55° C)

**NOTE:** For hard drives and solid state drives, GB = 1 billion bytes. TB = 1 trillion bytes. Actual formatted capacity is less. Up to 36 GB (for Windows 10) of system disk is reserved for the system recovery software.

### 2TB 5400RPM 2.5in SATA HDD

<b>Capacity</b>	2 TB
<b>Rotational Speed</b>	5,400 rpm
<b>Interface</b>	SATA 6 Gb/s
<b>Buffer Size</b>	128 MB
<b>Logical Blocks</b>	3,907,050,336
<b>Seek Time</b>	12 ms (Average)
<b>Height</b>	0.374 in/9.5 mm (Max.)
<b>Width (nominal)</b>	2.75 in/70 mm (nominal)
<b>Operating Temperature</b>	41° to 131° F (5° to 55° C)

**NOTE:** For hard drives and solid state drives, GB = 1 billion bytes. TB = 1 trillion bytes. Actual formatted capacity is less. Up to 36 GB (for Windows 10) of system disk is reserved for the system recovery software.

### 500GB 7200RPM 2.5in Self Encrypted OPAL2 SATA HDD

<b>Capacity</b>	500 GB
<b>Architecture</b>	Self-Encrypting (SED) Solid State Drive with SATA interface
<b>Interface</b>	SATA 6 Gb/s
<b>Buffer Size</b>	128 MB



## Technical Specifications – Storage

<b>Logical Blocks</b>	976,773,168
<b>Seek Time</b>	12 ms (Average)
<b>Height</b>	0.283 in/7.2 mm (Max.)
<b>Width</b>	2.75 in/70 mm (nominal)
<b>Operating Temperature</b>	41° to 131° F (5° to 55° C)

**NOTE:** For hard drives and solid state drives, GB = 1 billion bytes. TB = 1 trillion bytes. Actual formatted capacity is less. Up to 36 GB (for Windows 10) of system disk is reserved for the system recovery software.

### 500GB 7200RPM 2.5in Self Encrypted Federal Information Processing Standard SATA HDD

<b>Capacity</b>	500 GB
<b>Architecture</b>	Self-Encrypting (SED) Solid State Drive with SATA interface
<b>Interface</b>	SATA 6 Gb/s
<b>Buffer Size</b>	128 MB
<b>Logical Blocks</b>	976,773,168
<b>Seek Time</b>	12 ms (Average)
<b>Height</b>	0.283 in/7.2 mm (Max.)
<b>Width</b>	2.75 in/70 mm (nominal)
<b>Operating Temperature</b>	41° to 131° F (5° to 55° C)

**NOTE:** For hard drives and solid state drives, GB = 1 billion bytes. TB = 1 trillion bytes. Actual formatted capacity is less. Up to 36 GB (for Windows 10) of system disk is reserved for the system recovery software.

### 256GB M.2 2280 PCIe NVMe SSD

<b>Drive Weight</b>	< 10g
<b>Capacity</b>	256 GB
<b>Height</b>	2.38mm
<b>Length</b>	80mm
<b>Width</b>	22mm
<b>Interface</b>	PCIe Gen3
<b>Maximum Sequential Read</b>	Up to 1600MB/s
<b>Maximum Sequential Write</b>	Up to 780MB/s
<b>Logical Blocks</b>	500,118,192
<b>Operating Temperature</b>	0° to 70°C (32° to 158°F) [ambient temp]
<b>Features</b>	APST; ASPM L1.2; NVME spec 1.2

**NOTE:** For hard drives and solid state drives, GB = 1 billion bytes. TB = 1 trillion bytes. Actual formatted capacity is less. Up to 36 GB (for Windows 10) of system disk is reserved for the system recovery software.

### 512GB M.2 2280 PCIe NVMe SSD

<b>Drive Weight</b>	< 10g
<b>Capacity</b>	512 GB
<b>Height</b>	2.38mm
<b>Length</b>	80mm
<b>Width</b>	22mm
<b>Interface</b>	PCIe Gen3
<b>Maximum Sequential Read</b>	Up to 1600MB/s

## Technical Specifications – Storage

<b>Maximum Sequential Write</b>	Up to 860MB/s
<b>Logical Blocks</b>	1,000,215,216
<b>Operating Temperature</b>	0° to 70°C (32° to 158°F) [ambient temp]
<b>Features</b>	APST; ASPM L1.2; NVME spec 1.2

**NOTE:** For hard drives and solid state drives, GB = 1 billion bytes. TB = 1 trillion bytes. Actual formatted capacity is less. Up to 36 GB (for Windows 10) of system disk is reserved for the system recovery software.

**128GB M.2 2280 PCIe NVMe Three Layer Cell SSD**

<b>Drive Weight</b>	< 10g
<b>Capacity</b>	128 GB
<b>Height</b>	2.38mm
<b>Length</b>	80mm
<b>Width</b>	22mm
<b>Interface</b>	PCIe Gen3
<b>Maximum Sequential Read</b>	Up to 2800MB/s
<b>Maximum Sequential Write</b>	Up to 600MB/s
<b>Logical Blocks</b>	250,069,680
<b>Operating Temperature</b>	0° to 70°C (32° to 158°F) [ambient temp]
<b>Features</b>	APST; ASPM L1.2; NVME spec 1.2

**NOTE:** For hard drives and solid state drives, GB = 1 billion bytes. TB = 1 trillion bytes. Actual formatted capacity is less. Up to 36 GB (for Windows 10) of system disk is reserved for the system recovery software.

**256GB M.2 2280 PCIe NVMe Three Layer Cell SSD**

<b>Drive Weight</b>	< 10g
<b>Capacity</b>	256GB
<b>Height</b>	2.38mm
<b>Length</b>	80mm
<b>Width</b>	22mm
<b>Interface</b>	PCIe Gen3
<b>Maximum Sequential Read</b>	Up to 2700MB/s
<b>Maximum Sequential Write</b>	Up to 1000MB/s
<b>Logical Blocks</b>	500,118,192
<b>Operating Temperature</b>	0° to 70°C (32° to 158°F) [ambient temp]
<b>Features</b>	APST; ASPM L1.2; NVME spec 1.2

**NOTE:** For hard drives and solid state drives, GB = 1 billion bytes. TB = 1 trillion bytes. Actual formatted capacity is less. Up to 36 GB (for Windows 10) of system disk is reserved for the system recovery software.

**512GB M.2 2280 PCIe NVMe Three Layer Cell SSD**

<b>Drive Weight</b>	< 10g
<b>Capacity</b>	512 GB
<b>Height</b>	2.38mm
<b>Length</b>	80mm
<b>Width</b>	22mm
<b>Interface</b>	PCIe Gen3



## Technical Specifications – Storage

<b>Maximum Sequential Read</b>	Up to 2900MB/s
<b>Maximum Sequential Write</b>	Up to 1100MB/s
<b>Logical Blocks</b>	1,000,215,216
<b>Operating Temperature</b>	0° to 70°C (32° to 158°F) [ambient temp]
<b>Features</b>	APST; ASPM L1.2; NVME spec 1.2

**NOTE:** For hard drives and solid state drives, GB = 1 billion bytes. TB = 1 trillion bytes. Actual formatted capacity is less. Up to 36 GB (for Windows 10) of system disk is reserved for the system recovery software.

### 1 TB M.2 2280 PCIe NVMe Three Layer Cell SSD

<b>Drive Weight</b>	< 10g
<b>Capacity</b>	1 TB
<b>Height</b>	2.38mm
<b>Length</b>	80mm
<b>Width</b>	22mm
<b>Interface</b>	PCIe Gen3
<b>Maximum Sequential Read</b>	Up to 3480MB/s
<b>Maximum Sequential Write</b>	Up to 3037MB/s
<b>Logical Blocks</b>	2,000,409,264
<b>Operating Temperature</b>	0° to 70°C (32° to 158°F) [ambient temp]
<b>Features</b>	TRIM; ASPM L1.2

**NOTE:** For hard drives and solid state drives, GB = 1 billion bytes. TB = 1 trillion bytes. Actual formatted capacity is less. Up to 36 GB (for Windows 10) of system disk is reserved for the system recovery software.

### 2 TB M.2 2280 PCIe NVMe Three Layer Cell SSD

<b>Drive Weight</b>	< 10g
<b>Capacity</b>	2 TB
<b>Height</b>	2.38mm
<b>Length</b>	80mm
<b>Width</b>	22mm
<b>Interface</b>	PCIe Gen3
<b>Maximum Sequential Read</b>	Up to 3500MB/s
<b>Maximum Sequential Write</b>	Up to 3000MB/s
<b>Logical Blocks</b>	3,907,029,168
<b>Operating Temperature</b>	0° to 70°C (32° to 158°F) [ambient temp]
<b>Features</b>	TRIM; ASPM L1.2

**NOTE:** For hard drives and solid state drives, GB = 1 billion bytes. TB = 1 trillion bytes. Actual formatted capacity is less. Up to 36 GB (for Windows 10) of system disk is reserved for the system recovery software.

### 256GB M.2 2280 PCIe NVMe Self Encrypted OPAL2 Three Layer Cell SSD

<b>Drive Weight</b>	< 10g
<b>Capacity</b>	256 GB
<b>Height</b>	2.38mm
<b>Length</b>	80mm
<b>Width</b>	22mm

## Technical Specifications – Storage

<b>Interface</b>	PCIe Gen3
<b>Maximum Sequential Read</b>	Up to 2700MB/s
<b>Maximum Sequential Write</b>	Up to 1000MB/s
<b>Logical Blocks</b>	500,118,192
<b>Operating Temperature</b>	0° to 70°C (32° to 158°F) [ambient temp]
<b>Features</b>	APST; ASPM L1.2; NVME spec 1.2; TCG-OPAL2 security

**NOTE:** For hard drives and solid state drives, GB = 1 billion bytes. TB = 1 trillion bytes. Actual formatted capacity is less. Up to 36 GB (for Windows 10) of system disk is reserved for the system recovery software.

### 512GB M.2 2280 PCIe NVMe Self Encrypted OPAL2 Three Layer Cell SSD

<b>Drive Weight</b>	< 10g
<b>Capacity</b>	512 GB
<b>Height</b>	2.38mm
<b>Length</b>	80mm
<b>Width</b>	22mm
<b>Interface</b>	PCIe Gen3
<b>Maximum Sequential Read</b>	Up to 2900MB/s
<b>Maximum Sequential Write</b>	Up to 1100MB/s
<b>Logical Blocks</b>	1,000,215,216
<b>Operating Temperature</b>	0° to 70°C (32° to 158°F) [ambient temp]
<b>Features</b>	APST; ASPM L1.2; NVME spec 1.2; TCG-OPAL2 security

**NOTE:** For hard drives and solid state drives, GB = 1 billion bytes. TB = 1 trillion bytes. Actual formatted capacity is less. Up to 36 GB (for Windows 10) of system disk is reserved for the system recovery software.

### 256 GB Intel® PCIe® NVMe™ QLC + 32 GB Intel® Optane™

<b>Drive Weight</b>	< 10g
<b>Capacity</b>	256 GB
<b>Height</b>	2.38mm
<b>Length</b>	80mm
<b>Width</b>	22mm
<b>Interface</b>	PCIe Gen3
<b>Maximum Sequential Read</b>	Up to 1450MB/s
<b>Maximum Sequential Write</b>	Up to 500MB/s
<b>Logical Blocks</b>	500,118,192
<b>Operating Temperature</b>	0° to 70°C (32° to 158°F) [ambient temp]
<b>Features</b>	TRIM; ASPM L1.2

**NOTE:** For hard drives and solid state drives, GB = 1 billion bytes. TB = 1 trillion bytes. Actual formatted capacity is less. Up to 36 GB (for Windows 10) of system disk is reserved for the system recovery software.

### 512 GB Intel® PCIe® NVMe™ QLC + 32 GB Intel® Optane™

<b>Drive Weight</b>	< 10g
<b>Capacity</b>	512 GB
<b>Height</b>	2.38mm
<b>Length</b>	80mm

## Technical Specifications – Storage

<b>Width</b>	22mm
<b>Interface</b>	PCIe Gen3
<b>Maximum Sequential Read</b>	Up to 2400MB/s
<b>Maximum Sequential Write</b>	Up to 1300MB/s
<b>Logical Blocks</b>	1,000,215,215
<b>Operating Temperature</b>	0° to 70°C (32° to 158°F) [ambient temp]
<b>Features</b>	TRIM; ASPM L1.2

**NOTE:** For hard drives and solid state drives, GB = 1 billion bytes. TB = 1 trillion bytes. Actual formatted capacity is less. Up to 36 GB (for Windows 10) of system disk is reserved for the system recovery software.

### HP 9.5mm Slim DVD-ROM Drive

<b>Height</b>	9.5 mm height
<b>Orientation</b>	Either horizontal or vertical
<b>Interface type</b>	SATA/ATAPI
<b>Dimensions (W x H x D)</b>	5.04 x 0.37 x 5.0 in (128 x 9.5 x 127 mm) without bezel
<b>Weight (max)</b>	Up to 0.31 lb (140g) without bezel
<b>Read Speeds</b>	DVD+R/-R/+RW/ -RW/+R DL /-R DL Up to 8X DVD-ROM Up to 8X CD-ROM, CD-R Up to 24X CD-RW Up to 24X
<b>Access time (typical reads, including settling)</b>	Random: DVD-ROM: 170 ms (typical), CD-ROM: 170 ms (typical) Full stroke: DVD-ROM: 320 ms (typical), CD-ROM: 320 ms (typical)
<b>Power</b>	Source Slimline SATA DC power receptacle DC Power Requirement 5 VDC ± 5%-100 mV ripple p-p DC Current 5 VDC (< 1000 mA typical, 1600 mA maximum)
<b>Environmental conditions (operating - non-condensing)</b>	Temperature 41° to 122° F (5° to 50° C) Relative Humidity 10% to 80% Maximum Wet Bulb Temperature 84° F (29° C)

### HP 9.5mm Slim DVD Writer Drive

<b>Height</b>	9.5 mm height
<b>Orientation</b>	Either horizontal or vertical
<b>Interface type</b>	SATA/ATAPI
<b>Disc recording capacity</b>	Up to 8.5 GB DL or 4.7 GB standard
<b>Dimensions (W x H x D)</b>	5.04 x 0.37 x 5.0 in (128 x 9.5 x 127 mm) without bezel
<b>Weight (max)</b>	0.31 lb (140 g)
<b>Write Speeds</b>	DVD-R DL - Up to 6X DVD+R - Up to 8X DVD+RW - Up to 8X DVD+R DL - Up to 6X DVD-R - Up to 8X DVD-RW - Up to 6X CD-R - Up to 24X CD-RW - Up to 10X
<b>Read Speeds</b>	DVD-RW, DVD+RW - Up to 8X



## Technical Specifications – Storage

	DVD-R DL, DVD+R DL - Up to 8X DVD+R, DVD-R - Up to 8X DVD-ROM DL, DVD-ROM - Up to 8X CD-ROM, CD-R - Up to 24X CD-RW - Up to 24X
<b>Access time (typical reads, including settling)</b>	Random DVD-ROM: 170 ms (typical), CD-ROM: 170 ms (typical) Full Stroke DVD-ROM: 320 ms (typical), CD-ROM: 320 ms (typical) Stop Time 6 seconds (typical)
<b>Power</b>	Source Slimline SATA DC power receptacle DC Power Requirement 5 VDC ± 5%-100 mV ripple p-p DC Current 5 VDC (< 1000 mA typical, 1600 mA maximum)
<b>Environmental conditions (operating - non-condensing)</b>	Temperature 41° to 122° F (5° to 50° C) Relative Humidity 10% to 80% Maximum Wet Bulb Temperature 84° F (29° C)

### HP 9.5mm Slim Blu-Ray Writer Drive

<b>Height</b>	9.5 mm height
<b>Orientation</b>	Either horizontal or vertical
<b>Interface type</b>	SATA/ATAPI
<b>Disc recording capacity</b>	Up to 128 GB QL, 100 GB TL, 50 GB DL or 25 GB standard SL
<b>Dimensions (W x H x D)</b>	5.04 x 0.37 x 5.0 in (128 x 9.5 x 127 mm) without bezel
<b>Weight (max)</b>	0.29 lb (132 g)
<b>Write Speeds</b>	BD-R SL/DL Up to 6X BD-R TL/QL Up to 4X BD-RE Up to 2X DVD-R Up to 8X DVD-R DL - Up to 6X DVD-RW Up to 6X DVD+R Up to 8X DVD+R DL - Up to 6X DVD+RW Up to 8X DVD-RAM Up to 5X CD-R Up to 24X CD-RW Up to 10X
<b>Read Speeds</b>	BD-ROM Up to 6X BD-R Up to 6X BD-RE SL/DL Up to 6X BD-RE TL Up to 4X DVD-ROM Up to 8X DVD-R SL/DL Up to 8X DVD-R Up to 8X DVD-RW Up to 8X DVD+R SL/DL Up to 8X DVD+R Up to 8X DVD+RW Up to 8X BDMV (AACIS Compliant Disc) Up to 6x/2x (Read/Play) DVD-RAM Up to 5x DVD-Video (CSS Compliant Disc) Up to 8x/4x (Read/Play)

## Technical Specifications – Storage

<b>Access time (typical reads, including settling)</b>	CD-R/RW/ROM Up to 24x CD-DA (DAE) Up to 24X/10X (Read/Play) Random BD-ROM: 205 ms (typical), DVD-ROM: 185 ms (typical), CD-ROM: 165 ms (typical) Full Stroke BD-ROM: 350 ms (typical), DVD-ROM: 345 ms (typical), CD-ROM: 340 ms (typical)
<b>Power</b>	Source Slimline SATA DC power receptacle DC Power Requirement 5 VDC $\pm$ 5%-100 mV ripple p-p DC Current 5 VDC -1200 mA typical, 2000 mA maximum
<b>Environmental conditions (operating - non-condensing)</b>	Temperature 41° to 122° F (5° to 50° C) Relative Humidity 10% to 80% Maximum Wet Bulb Temperature 84° F (29° C)

## Technical Specifications – Networking

### NETWORKING AND COMMUNICATIONS

<b>Intel® i219LM 10/100/1000 Integrated NIC</b>	
<b>Connector</b>	RJ-45
<b>System Interface</b>	PCI (Intel® proprietary) + SMBus
<b>Data rates supported</b>	10 Mbit/s operation (10BASE-T; IEEE 802.3i; IEEE 802.3 clauses 13-14) 100 Mbit/s operation (100BASE-TX; IEEE 802.3u; IEEE 802.3 clauses 21-30) 1000 Mbit/s operation (1000BASE-T; IEEE 802.3ab; IEEE 802.3 clauses 40) Auto-Negotiation (Automatic Speed Selection) Full Duplex Operation at all Speeds, Half Duplex operation at 10 and 100 Mbit/s
<b>IEEE Compliance</b>	IEEE 802.1p QoS (Quality of Service) Support IEEE 802.1q VLAN support IEEE 802.3x Flow Control (IEEE 802.3 clauses 31-32; configurable) IEEE 802.3az EEE (Energy Efficient Ethernet)
<b>Performance</b>	TCP/IP/UDP Checksum Offload (configurable) Protocol Offload (ARP & NS) Large send offload and Giant send offload Receiving Side Scaling Jumbo Frame 9K
<b>Power consumption</b>	Cable Disconnection: 25mW 100Mbps Full Run: 450mW 1000bp Full Run: 1000mW WoL Enable(S3/S4/S5): 50mW WoL Disable(S3/S4/S5): 25mW
<b>Power Management</b>	ACPI compliant – multiple power modes Situation-sensitive features reduce power consumption Advanced link down power saving for reducing link down power consumption
<b>Management Interface</b>	Auto MDI/MDIX Crossover cable detection
<b>IT Manageability</b>	Wake-on-LAN from standby and hibernation (Magic Packet and Microsoft Wake-Up Frame); Wake-on-LAN from off (Magic Packet only) PXE 2.1 Remote Boot Statistics Gathering (SNMP MIB II, Ethernet-like MIB, Ethernet MIB (802.3x, clause 30)) Comprehensive diagnostic and configuration software suite Virtual Cable Doctor for Ethernet cable status
<b>Security &amp; Manageability</b>	Intel® vPro™ support with appropriate Intel® chipset components

<b>Intel® Ethernet Controller I210-AT Add-On Card</b>	
<b>Connector</b>	RJ-45
<b>System Interface</b>	PCIe + SMBus
<b>Data rates supported</b>	10 Mbit/s operation (10BASE-T; IEEE 802.3i; IEEE 802.3 clauses 13-14) 100 Mbit/s operation (100BASE-TX; IEEE 802.3u; IEEE 802.3 clauses 21-30) 1000 Mbit/s operation (1000BASE-T; IEEE 802.3ab; IEEE 8023 clauses 40) Auto-Negotiation (Automatic Speed Selection) Full Duplex Operation at all Speeds, Half Duplex operation at 10 and 100 Mbit/s
<b>IEEE Compliance</b>	IEEE 802.1p QoS (Quality of Service) Support IEEE 802.1q VLAN support IEEE 802.3x Flow Control (IEEE 802.3 clauses 31-32; configurable) IEEE 802.3az EEE (Energy Efficient Ethernet)

## Technical Specifications – Networking

<b>Performance</b>	TCP/IP/UDP Checksum Offload (configurable) Protocol Offload (ARP & NS) Large send offload and Giant send offload Receiving Side Scaling Jumbo Frame 9K
<b>Power consumption</b>	Cable Disconnection: 25mW 100Mbps Full Run: 450mW 1000bp Full Run: 1000mW WoL Enable(S3/S4/S5): 50mW WoL Disable(S3/S4/S5): 25mW
<b>Power Management</b>	ACPI compliant – multiple power modes Situation-sensitive features reduce power consumption Advanced link down power saving for reducing link down power consumption
<b>Management Interface</b>	Auto MDI/MDIX Crossover cable detection
<b>IT Manageability</b>	Wake-on-LAN from standby and hibernation (Magic Packet and Microsoft Wake-Up Frame); Wake-on-LAN from off (Magic Packet only) PXE 2.1 Remote Boot Statistics Gathering (SNMP MIB II, Ethernet-like MIB, Ethernet MIB (802.3x, clause 30)) Comprehensive diagnostic and configuration software suite Virtual Cable Doctor for Ethernet cable status
<b>Security &amp; Manageability</b>	Intel® vPro™ support with appropriate Intel® chipset components

<b>Intel® Wi-Fi 6 AX201 + BT5 (802.11ax 2x2, non-vPro, supporting gigabit file transfer speeds)</b>	
<b>Wireless LAN Standards</b>	IEEE 802.11a IEEE 802.11b IEEE 802.11g IEEE 802.11n IEEE 802.11ac IEEE 802.11ax IEEE 802.11d IEEE 802.11e IEEE 802.11h IEEE 802.11i IEEE 802.11k IEEE 802.11r IEEE 802.11v
<b>Interoperability</b>	Features Wi-Fi 6 technology
<b>Frequency Band</b>	802.11b/g/n/ax • 2.402 – 2.482 GHz 802.11a/n/ac/ax • 4.9 – 4.95 GHz (Japan) • 5.15 – 5.25 GHz • 5.25 – 5.35 GHz • 5.47 – 5.725 GHz • 5.825 – 5.850 GHz
<b>Data Rates</b>	802.11b: 1, 2, 5.5, 11 Mbps • 802.11g: 6, 9, 12, 18, 24, 36, 48, 54 Mbps • 802.11a: 6, 9, 12, 18, 24, 36, 48, 54 Mbps • 802.11n: MCS 0 ~ MCS 15, (20MHz, and 40MHz) • 802.11ac : MCS0 ~ MCS9, (1SS, and 2SS) (20MHz, 40MHz, ,80MHz & 160MHz) • 802.11ax : MCS0 ~ MCS11, (1SS and 2SS) (20MHz, 40MHz, ,80MHz & 160MHz)
<b>Modulation</b>	Direct Sequence Spread Spectrum OFDM, BPSK, QPSK, CCK, 16-QAM, 64-QAM, 256-QAM, 1024QAM

## Technical Specifications – Networking

<b>Security</b>	<ul style="list-style-type: none"> <li>• IEEE compliant 64 / 128 bit WEP encryption for a/b/g mode only</li> <li>• AES-CCMP: 128 bit in hardware</li> <li>• 802.1x authentication</li> <li>• WPA, WPA2: 802.1x. WPA-PSK, WPA2-PSK, TKIP, and AES.</li> <li>• WPA2 certification</li> <li>• IEEE 802.11i</li> <li>• WAPI</li> </ul>	
<b>Network Architecture Models</b>	Ad-hoc (Peer to Peer) Infrastructure (Access Point Required)	
<b>Roaming</b>	IEEE 802.11 compliant roaming between access points	
<b>Output Power</b>	<ul style="list-style-type: none"> <li>• 802.11b : +18.5dBm minimum</li> <li>• 802.11g : +17.5dBm minimum</li> <li>• 802.11a : +18.5dBm minimum</li> <li>• 802.11n HT20(2.4GHz) : +15.5dBm minimum</li> <li>• 802.11n HT40(2.4GHz) : +14.5dBm minimum</li> <li>• 802.11n HT20(5GHz) : +15.5dBm minimum</li> <li>• 802.11n HT40(5GHz) : +14.5dBm minimum</li> <li>• 802.11ac VHT80(5GHz) : +11.5dBm minimum</li> <li>• 802.11ac VHT160(5GHz) : +11.5dBm minimum</li> <li>• 802.11ax HT40(2.4GHz) : +10dBm minimum</li> <li>• 802.11ax VHT160(5GHz) : +10dBm minimum</li> </ul>	
<b>Power Consumption</b>	<ul style="list-style-type: none"> <li>• Transmit mode 2.0 W</li> <li>• Receive mode 1.6 W</li> <li>• Idle mode (PSP) 180 mW (WLAN Associated)</li> <li>• Idle mode 50 mW (WLAN unassociated)</li> <li>• Connected Standby 10mW</li> <li>• Radio disabled 8 mW</li> </ul>	
<b>Power Management</b>	ACPI and PCI Express compliant power management 802.11 compliant power saving mode	
<b>Receiver Sensitivity</b>	802.11b, 1Mbps : -93.5dBm maximum 802.11b, 11Mbps : -84dBm maximum 802.11a/g, 6Mbps : -86dBm maximum 802.11a/g, 54Mbps : -72dBm maximum 802.11n, MCS07 : -67dBm maximum 802.11n, MCS15 : -64dBm maximum 802.11ac, MCS0 : -84dBm maximum 802.11ac, MCS9 : -59dBm maximum	
<b>Antenna type</b>	High efficiency antenna with spatial diversity, mounted in the display enclosure Two embedded dual band 2.4/5 GHz antennas are provided to the card to support WLAN MIMO communications and Bluetooth communications	
<b>Form Factor</b>	PCI-Express M.2 MiniCard with CNVi Interface	
<b>Dimensions</b>	1. Type 2230 : 2.3 x 22.0 x 30.0 mm 2. Type 1216: 1.67 x 12.0 x 16.0 mm	
<b>Weight</b>	1. Type 2230 : 2.8g 2. Type 126: 1.3g	
<b>Operating Voltage</b>	3.3v +/- 9%	
<b>Temperature</b>	Operating	14° to 158° F (-10° to 70° C)
	Non-operating	-40° to 176° F (-40° to 80° C)
<b>Humidity</b>	Operating	10% to 90% (non-condensing)
	Non-operating	5% to 95% (non-condensing)
<b>Altitude</b>	Operating	0 to 10,000 ft (3,048 m)
	Non-operating	0 to 50,000 ft (15,240 m)
<b>LED Activity</b>	LED Amber – Radio OFF; LED Off – Radio ON	



## Technical Specifications – Networking

<b>HP Integrated Module with Bluetooth 4.0/4.1/4.2/5.0/5.1 Wireless Technology</b>	
<b>Bluetooth® Specification</b>	4.0/4.1/4.2/5.0/5.1 Compliant
<b>Frequency Band</b>	2402 to 2480 MHz
<b>Number of Available Channels</b>	Legacy: 0~79 (1 MHz/CH) BLE: 0~39 (2 MHz/CH)
<b>Data Rates and Throughput</b>	Legacy: 3 Mbps data rate; throughput up to 2.17 Mbps
	BLE: 1 Mbps data rate; throughput up to 0.2 Mbps
	Legacy: Synchronous Connection Oriented links up to 3, 64 kbps, voice channels Legacy: Asynchronous Connection Less links 2178.1 kbps/177.1 kbps asymmetric (3-DH5) or 864 kbps symmetric (3-EV5)
<b>Transmit Power</b>	The Bluetooth® component shall operate as a Class II Bluetooth device with a maximum transmit power of + 9.5 dBm for BR and EDR.
<b>Power Consumption</b>	Peak (Tx) 330 mW Peak (Rx) 230 mW Selective Suspend 17 mW
<b>Bluetooth® Software Supported Link Topology</b>	Microsoft Windows Bluetooth® Software
<b>Power Management</b>	Microsoft Windows ACPI, and USB Bus Support
<b>Certifications</b>	FCC (47 CFR) Part 15C, Section 15.247 & 15.249
<b>Power Management</b>	ETS 300 328, ETS 300 826
<b>Certifications</b>	Low Voltage Directive IEC60950-1/IEC62368-1  UL, CSA, and CE Mark
<b>Bluetooth Profiles Supported</b>	BT4.1-ESR 5/6/7 Compliance LE Link Layer Ping LE Dual Mode LE Link Layer LE Low Duty Cycle Directed Advertising LE L2CAP Connection Oriented Channels Train Nudging & Interlaced Scan BT4.2 ESR08 Compliance LE Secure Connection- Basic/Full LE Privacy 1.2 –Link Layer Privacy LE Privacy 1.2 –Extended Scanner Filter Policies LE Data Packet Length Extension FAX Profile (FAX) Basic Imaging Profile (BIP)2 Headset Profile (HSP) Hands Free Profile (HFP) Advanced Audio Distribution Profile (A2DP)

<b>Intel Wi-Fi 6 AX201 + BT5 (802.11ax 2x2, vPro, supporting gigabit file transfer speeds)</b>	
<b>Wireless LAN Standards</b>	IEEE 802.11a IEEE 802.11b IEEE 802.11g IEEE 802.11n IEEE 802.11ac IEEE 802.11ax IEEE 802.11d IEEE 802.11e

## Technical Specifications – Networking

	<p>IEEE 802.11h          IEEE 802.11i          IEEE 802.11k          IEEE 802.11r          IEEE 802.11v</p>
<b>Interoperability</b>	Features Wi-Fi 6 technology
<b>Frequency Band</b>	<p>802.11b/g/n/ax</p> <ul style="list-style-type: none"> <li>• 2.402 – 2.482 GHz</li> </ul> <p>802.11a/n/ac/ax</p> <ul style="list-style-type: none"> <li>• 4.9 – 4.95 GHz (Japan)</li> <li>• 5.15 – 5.25 GHz</li> <li>• 5.25 – 5.35 GHz</li> <li>• 5.47 – 5.725 GHz</li> <li>• 5.825 – 5.850 GHz</li> </ul>
<b>Data Rates</b>	<ul style="list-style-type: none"> <li>• 802.11b: 1, 2, 5.5, 11 Mbps</li> <li>• 802.11g: 6, 9, 12, 18, 24, 36, 48, 54 Mbps</li> <li>• 802.11a: 6, 9, 12, 18, 24, 36, 48, 54 Mbps</li> <li>• 802.11n: MCS 0 ~ MCS 15, (20MHz, and 40MHz)</li> <li>• 802.11ac : MCS0 ~ MCS9, (1SS, and 2SS) (20MHz, 40MHz, ,80MHz &amp; 160MHz)</li> <li>• 802.11ax : MCS0 ~ MCS11, (1SS and 2SS) (20MHz, 40MHz, ,80MHz &amp; 160MHz)</li> </ul>
<b>Modulation</b>	<p>Direct Sequence Spread Spectrum          OFDM, BPSK, QPSK, CCK, 16-QAM, 64-QAM, 256-QAM, 1024QAM</p>
<b>Security</b>	<ul style="list-style-type: none"> <li>• IEEE compliant 64 / 128 bit WEP encryption for a/b/g mode only</li> <li>• AES-CCMP: 128 bit in hardware</li> <li>• 802.1x authentication</li> <li>• WPA, WPA2: 802.1x. WPA-PSK, WPA2-PSK, TKIP, and AES.</li> <li>• WPA2 certification</li> <li>• IEEE 802.11i</li> <li>• WAPI</li> </ul>
<b>Network Architecture Models</b>	<p>Ad-hoc (Peer to Peer)          Infrastructure (Access Point Required)</p>
<b>Roaming</b>	IEEE 802.11 compliant roaming between access points
<b>Output Power</b>	<ul style="list-style-type: none"> <li>• 802.11b : +18.5dBm minimum</li> <li>• 802.11g : +17.5dBm minimum</li> <li>• 802.11a : +18.5dBm minimum</li> <li>• 802.11n HT20(2.4GHz) : +15.5dBm minimum</li> <li>• 802.11n HT40(2.4GHz) : +14.5dBm minimum</li> <li>• 802.11n HT20(5GHz) : +15.5dBm minimum</li> <li>• 802.11n HT40(5GHz) : +14.5dBm minimum</li> <li>• 802.11ac VHT80(5GHz) : +11.5dBm minimum</li> <li>• 802.11ac VHT160(5GHz) : +11.5dBm minimum</li> <li>• 802.11ax HT40(2.4GHz) : +10dBm minimum</li> <li>• 802.11ax VHT160(5GHz) : +10dBm minimum</li> </ul>
<b>Power Consumption</b>	<ul style="list-style-type: none"> <li>• Transmit mode :2.0 W</li> <li>• Receive mode :1.6 W</li> <li>• Idle mode (PSP) 180 mW (WLAN Associated)</li> <li>• Idle mode :50 mW (WLAN unassociated)</li> <li>• Connected Standby/Modern Standby: 10mW</li> <li>• Radio disabled: 8 mW</li> </ul>
<b>Power Management</b>	<p>ACPI and PCI Express compliant power management          802.11 compliant power saving mode</p>
<b>Receiver Sensitivity</b>	<ul style="list-style-type: none"> <li>• 802.11b, 1Mbps : -93.5dBm maximum</li> <li>• 802.11b, 11Mbps : -84dBm maximum</li> <li>• 802.11a/g, 6Mbps : -86dBm maximum</li> </ul>

## Technical Specifications – Networking

	<ul style="list-style-type: none"> <li>• 802.11a/g, 54Mbps : -72dBm maximum</li> <li>• 802.11n, MCS07 : -67dBm maximum</li> <li>• 802.11n, MCS15 : -64dBm maximum</li> <li>• 802.11ac, MCS0 : -84dBm maximum</li> <li>• 802.11ac, MCS9 : -59dBm maximum</li> <li>• 802.11ax, MCS11(HT40): -59dBm maximum</li> <li>• 802.11ax, MCS11(VHT160): -58.5dBm maximum</li> </ul>	
<b>Antenna type</b>	High efficiency antenna with spatial diversity, mounted in the display enclosure	
	Two embedded dual band 2.4/5 GHz antennas are provided to the card to support WLAN MIMO communications and Bluetooth communications	
<b>Form Factor</b>	PCI-Express M.2 MiniCard with CNVi Interface	
<b>Dimensions</b>	1. Type 2230 : 2.3 x 22.0 x 30.0 mm 2. Type 1216: 1.67 x 12.0 x 16.0 mm	
<b>Weight</b>	1. Type 2230 : 2.8g 2. Type 126: 1.3g	
<b>Operating Voltage</b>	3.3v +/- 9%	
<b>Temperature</b>	Operating	14° to 158° F (-10° to 70° C)
	Non-operating	-40° to 176° F (-40° to 80° C)
<b>Humidity</b>	Operating	10% to 90% (non-condensing)
	Non-operating	5% to 95% (non-condensing)
<b>Altitude</b>	Operating	0 to 10,000 ft (3,048 m)
	Non-operating	0 to 50,000 ft (15,240 m)
<b>LED Activity</b>	LED Amber – Radio OFF; LED White – Radio ON	
<b>HP Integrated Module with Bluetooth 4.0/4.1/4.2/5.0/5.1 Wireless Technology</b>		
<b>Bluetooth® Specification</b>	4.0/4.1/4.2/5.0/5.1 Compliant	
<b>Frequency Band</b>	2402 to 2480 MHz	
<b>Number of Available Channels</b>	Legacy: 0~79 (1 MHz/CH) BLE: 0~39 (2 MHz/CH)	
<b>Data Rates and Throughput</b>	Legacy: 3 Mbps data rate; throughput up to 2.17 Mbps	
	BLE: 1 Mbps data rate; throughput up to 0.2 Mbps	
	Legacy: Synchronous Connection Oriented links up to 3, 64 kbps, voice channels	
	Legacy: Asynchronous Connection Less links 2178.1 kbps/177.1 kbps asymmetric (3-DH5) or 864 kbps symmetric (3-EV5)	
<b>Transmit Power</b>	The Bluetooth® component shall operate as a Class II Bluetooth® device with a maximum transmit power of +9.5 dBm for BR and EDR.	
<b>Power Consumption</b>	Peak (Tx) 330 mW Peak (Rx) 230 mW Selective Suspend 17 mW	
<b>Bluetooth® Software Supported Link Topology</b>	Microsoft Windows Bluetooth® Software	
<b>Power Management</b>	Microsoft Windows ACPI, and USB Bus Support	
<b>Certifications</b>	FCC (47 CFR) Part 15C, Section 15.247 & 15.249	
<b>Power Management</b>	ETS 300 328, ETS 300 826	
<b>Certifications</b>	Low Voltage Directive IEC60950-1/IEC62368-1	
	UL, CSA, and CE Mark FCC (47 CFR) Part 15C, Section 15.247 & 15.249	
<b>Bluetooth Profiles Supported</b>	BT4.1-ESR 5/6/7 Compliance LE Link Layer Ping LE Dual Mode	

## Technical Specifications – Networking

	<p>LE Link Layer          LE Low Duty Cycle Directed Advertising          LE L2CAP Connection Oriented Channels          Train Nudging &amp; Interlaced Scan          BT4.2 ESR08 Compliance          LE Secure Connection- Basic/Full          LE Privacy 1.2 –Link Layer Privacy          LE Privacy 1.2 –Extended Scanner Filter Policies          LE Data Packet Length Extension          FAX Profile (FAX)          Basic Imaging Profile (BIP)2          Headset Profile (HSP)          Hands Free Profile (HFP)          Advanced Audio Distribution Profile (A2DP)</p>
<b>Security &amp; Manageability</b>	Intel® vPro™ support with appropriate Intel® chipset components

<b>Realtek RTL8821CE 802.11ac 1x1 Wi-Fi® and Bluetooth® 4.2 Combo</b>	
<b>Wireless LAN Standards</b>	<p>IEEE 802.11a            IEEE 802.11b            IEEE 802.11g            IEEE 802.11n            IEEE 802.11ac            IEEE 802.11d            IEEE 802.11e            IEEE 802.11h            IEEE 802.11i            IEEE 802.11k            IEEE 802.11r            IEEE 802.11v</p>
<b>Interoperability</b>	Wi-Fi® certified
<b>Frequency Band</b>	<p>802.11b/g/n            • 2.402 – 2.482 GHz            802.11a/n/ac            • 4.9 – 4.95 GHz (Japan)            • 5.15 – 5.25 GHz            • 5.25 – 5.35 GHz            • 5.47 – 5.725 GHz            • 5.825 – 5.850 GHz</p>
<b>Data Rates</b>	<p>• 802.11b: 1, 2, 5.5, 11 Mbps            • 802.11g: 6, 9, 12, 18, 24, 36, 48, 54 Mbps            • 802.11a: 6, 9, 12, 18, 24, 36, 48, 54 Mbps            • 802.11n: MCS 0 ~ MCS 15, (20MHz, and 40MHz)            • 802.11ac : MCS0 ~ MCS9, (1SS, and 2SS) (20MHz, 40MHz, and 80MHz)</p>
<b>Modulation</b>	<p>Direct Sequence Spread Spectrum            BPSK, QPSK, CCK, 16-QAM, 64-QAM, 256-QAM</p>
<b>Security</b>	<ul style="list-style-type: none"> <li>• IEEE and WiFi compliant 64 / 128 bit WEP encryption for a/b/g mode only</li> <li>• AES-CCMP: 128 bit in hardware</li> <li>• 802.1x authentication</li> <li>• WPA, WPA2: 802.1x. WPA-PSK, WPA2-PSK, TKIP, and AES.</li> <li>• WPA2 certification</li> <li>• IEEE 802.11i</li> <li>• WAPI</li> </ul>
<b>Network Architecture Models</b>	<p>Ad-hoc (Peer to Peer)            Infrastructure (Access Point Required)</p>
<b>Roaming</b>	IEEE 802.11 compliant roaming between access points



## Technical Specifications – Networking

<b>Output Power</b>	<ul style="list-style-type: none"> <li>• 802.11b : +14dBm minimum</li> <li>• 802.11g : +12dBm minimum</li> <li>• 802.11a : +12dBm minimum</li> <li>• 802.11n HT20(2.4GHz) : +12dBm minimum</li> <li>• 802.11n HT40(2.4GHz) : +12dBm minimum</li> <li>• 802.11n HT20(5GHz) : +10dBm minimum</li> <li>• 802.11n HT40(5GHz) : +10dBm minimum</li> <li>• 802.11ac VHT80(5GHz) : +10dBm minimum</li> </ul>	
<b>Power Consumption</b>	<ul style="list-style-type: none"> <li>• Transmit mode 2.0 W</li> <li>• Receive mode 1.6 W</li> <li>• Idle mode (PSP) 180 mW (WLAN Associated)</li> <li>• Idle mode 50 mW (WLAN unassociated)</li> <li>• Connected Standby 10mW</li> <li>• Radio disabled 8 mW</li> </ul>	
<b>Power Management</b>	ACPI and PCI Express compliant power management 802.11 compliant power saving mode	
<b>Receiver Sensitivity</b>	802.11b, 1Mbps: -93.5dBm maximum 802.11b, 11Mbps: -84dBm maximum 802.11a/g, 6Mbps: -86dBm maximum 802.11a/g, 54Mbps: -72dBm maximum 802.11n, MCS07: -67dBm maximum 802.11n, MCS15: -64dBm maximum 802.11ac, MCS0: -84dBm maximum 802.11ac, MCS9: -59dBm maximum	
<b>Antenna type</b>	High efficiency antenna. One embedded dual band 2.4/5 GHz antenna is provided to the card to support WLAN communications and Bluetooth communications	
<b>Form Factor</b>	PCI-Express M.2 MiniCard	
<b>Dimensions</b>	Type 2230: 2.3 x 22.0 x 30.0 mm	
<b>Weight</b>	Type 2230: 2.8g	
<b>Operating Voltage</b>	3.3v +/- 9%	
<b>Temperature</b>	Operating	14° to 158° F (-10° to 70° C)
	Non-operating	-40° to 176° F (-40° to 80° C)
<b>Humidity</b>	Operating	10% to 90% (non-condensing)
	Non-operating	5% to 95% (non-condensing)
<b>Altitude</b>	Operating	0 to 10,000 ft (3,048 m)
	Non-operating	0 to 50,000 ft (15,240 m)
<b>LED Activity</b>	LED Amber – Radio OFF; LED Off – Radio ON	
<b>HP Integrated Module with Bluetooth 4.0/4.1/4.2 Wireless Technology</b>		
<b>Bluetooth® Specification</b>	4.0/4.1/4.2 Compliant	
<b>Frequency Band</b>	2402 to 2480 MHz	
<b>Number of Available Channels</b>	Legacy: 0~79 (1 MHz/CH) BLE: 0~39 (2 MHz/CH)	
<b>Data Rates and Throughput</b>	Legacy: 3 Mbps data rate; throughput up to 2.17 Mbps	
	BLE: 1 Mbps data rate; throughput up to 0.2 Mbps	
	Legacy: Synchronous Connection Oriented links up to 3, 64 kbps, voice channels	
	Legacy: Asynchronous Connection Less links 2178.1 kbps/177.1 kbps asymmetric (3-DH5) or 864 kbps symmetric (3-EV5)	
<b>Transmit Power</b>	The Bluetooth component shall operate as a Class II Bluetooth device with a maximum transmit power of + 4 dBm for BR and EDR.	
<b>Power Consumption</b>	Peak (Tx) 330 mW Peak (Rx) 230 mW Selective Suspend 17 mW	
<b>Electrical Interface</b>	USB 2.0 compliant	
<b>Bluetooth® Software Supported</b>	Microsoft Windows Bluetooth® Software	



## Technical Specifications – Networking

<b>Link Topology</b>	
<b>Power Management</b>	Microsoft Windows ACPI, and USB Bus Support
<b>Certifications</b>	FCC (47 CFR) Part 15C, Section 15.247 & 15.249
<b>Power Management</b>	ETS 300 328, ETS 300 826
<b>Certifications</b>	Low Voltage Directive IEC60950-1/IEC62368-1 UL, CSA, and CE Mark FCC (47 CFR) Part 15C, Section 15.247 & 15.249
<b>Bluetooth Profiles Supported</b>	BT4.1-ESR 5/6/7 Compliance LE Link Layer Ping LE Dual Mode LE Link Layer LE Low Duty Cycle Directed Advertising LE L2CAP Connection Oriented Channels Train Nudging & Interlaced Scan BT4.2 ESR08 Compliance LE Secure Connection- Basic/Full LE Privacy 1.2 –Link Layer Privacy LE Privacy 1.2 –Extended Scanner Filter Policies LE Data Packet Length Extension FAX Profile (FAX) Basic Imaging Profile (BIP)2 Headset Profile (HSP) Hands Free Profile (HFP) Advanced Audio Distribution Profile (A2DP)

<b>Realtek RTL8822CE 802.11ac 2x2 Wi-Fi® + BT5</b>	
<b>Wireless LAN Standards</b>	IEEE 802.11a IEEE 802.11b IEEE 802.11g IEEE 802.11n IEEE 802.11ac IEEE 802.11d IEEE 802.11e IEEE 802.11h IEEE 802.11i IEEE 802.11k IEEE 802.11r IEEE 802.11v
<b>Interoperability</b>	Wi-Fi® certified
<b>Frequency Band</b>	802.11b/g/n • 2.402 – 2.482 GHz 802.11a/n/ac • 4.9 – 4.95 GHz (Japan) • 5.15 – 5.25 GHz • 5.25 – 5.35 GHz • 5.47 – 5.725 GHz • 5.825 – 5.850 GHz
<b>Data Rates</b>	• 802.11b: 1, 2, 5.5, 11 Mbps • 802.11g: 6, 9, 12, 18, 24, 36, 48, 54 Mbps • 802.11a: 6, 9, 12, 18, 24, 36, 48, 54 Mbps • 802.11n: MCS 0 ~ MCS 15, (20MHz, and 40MHz) • 802.11ac : MCS0 ~ MCS9, (1SS, and 2SS) (20MHz, 40MHz & 80MHz)



## Technical Specifications – Networking

<b>Modulation</b>	Direct Sequence Spread Spectrum BPSK, QPSK, CCK, 16-QAM, 64-QAM, 256-QAM	
<b>Security</b>	<ul style="list-style-type: none"> <li>• IEEE and WiFi compliant 64 / 128 bit WEP encryption for a/b/g mode only</li> <li>• AES-CCMP: 128 bit in hardware</li> <li>• 802.1x authentication</li> <li>• WPA, WPA2: 802.1x. WPA-PSK, WPA2-PSK, TKIP, and AES.</li> <li>• WPA2 certification</li> <li>• IEEE 802.11i</li> <li>• WAPI</li> </ul>	
<b>Network Architecture Models</b>	Ad-hoc (Peer to Peer) Infrastructure (Access Point Required)	
<b>Roaming</b>	IEEE 802.11 compliant roaming between access points	
<b>Output Power</b>	<ul style="list-style-type: none"> <li>• 802.11b : +18.5dBm minimum</li> <li>• 802.11g : +17.5dBm minimum</li> <li>• 802.11a : +18.5dBm minimum</li> <li>• 802.11n HT20(2.4GHz) : +15.5dBm minimum</li> <li>• 802.11n HT40(2.4GHz) : +14.5dBm minimum</li> <li>• 802.11n HT20(5GHz) : +15.5dBm minimum</li> <li>• 802.11n HT40(5GHz) : +14.5dBm minimum</li> <li>• 802.11ac VHT80(5GHz) : +11.5dBm minimum</li> <li>• 802.11ac VHT160(5GHz) : +11.5dBm minimum</li> </ul>	
<b>Power Consumption</b>	<ul style="list-style-type: none"> <li>• Transmit mode :2.0 W</li> <li>• Receive mode :1.6 W</li> <li>• Idle mode (PSP) 180 mW (WLAN Associated)</li> <li>• Idle mode :50 mW (WLAN unassociated)</li> <li>• Connected Standby/Modern Standby: 10mW</li> <li>• Radio disabled: 8 mW</li> </ul>	
<b>Power Management</b>	ACPI and PCI Express compliant power management 802.11 compliant power saving mode	
<b>Receiver Sensitivity</b>	802.11b, 1Mbps : -93.5dBm maximum 802.11b, 11Mbps : -84dBm maximum 802.11a/g, 6Mbps : -86dBm maximum 802.11a/g, 54Mbps : -72dBm maximum 802.11n, MCS07 : -67dBm maximum 802.11n, MCS15 : -64dBm maximum 802.11ac, MCS0 : -84dBm maximum 802.11ac, MCS9 : -59dBm maximum	
<b>Antenna type</b>	High efficiency antenna with spatial diversity, mounted in the display enclosure Two embedded dual band 2.4/5 GHz antennas are provided to the card to support WLAN MIMO communications and Bluetooth communications	
<b>Form Factor</b>	PCI-Express M.2 MiniCard with CNVi Interface	
<b>Dimensions</b>	1. Type 2230 : 2.3 x 22.0 x 30.0 mm 2. Type 1216: 1.67 x 12.0 x 16.0 mm	
<b>Weight</b>	1. Type 2230 : 2.8g 2. Type 126: 1.3g	
<b>Operating Voltage</b>	3.3v +/- 9%	
<b>Temperature</b>	Operating	14° to 158° F (-10° to 70° C)
	Non-operating	-40° to 176° F (-40° to 80° C)
<b>Humidity</b>	Operating	10% to 90% (non-condensing)
	Non-operating	5% to 95% (non-condensing)
<b>Altitude</b>	Operating	0 to 10,000 ft (3,048 m)
	Non-operating	0 to 50,000 ft (15,240 m)
<b>LED Activity</b>	LED Amber – Radio OFF; LED Off – Radio ON	
<b>HP Integrated Module with Bluetooth 4.0/4.1/4.2/5.0 Wireless Technology</b>		

## Technical Specifications – Networking

<b>Bluetooth® Specification</b>	4.0/4.1/4.2/5.0 Compliant
<b>Frequency Band</b>	2402 to 2480 MHz
<b>Number of Available Channels</b>	Legacy: 0~79 (1 MHz/CH) BLE: 0~39 (2 MHz/CH)
<b>Data Rates and Throughput</b>	Legacy: 3 Mbps data rate; throughput up to 2.17 Mbps BLE: 1 Mbps data rate; throughput up to 0.2 Mbps Legacy: Synchronous Connection Oriented links up to 3, 64 kbps, voice channels Legacy: Asynchronous Connection Less links 2178.1 kbps/177.1 kbps asymmetric (3-DH5) or 864 kbps symmetric (3-EV5)
<b>Transmit Power</b>	The Bluetooth® component shall operate as a Class II Bluetooth® device with a maximum transmit power of +4 dBm for BR and EDR.
<b>Power Consumption</b>	Peak (Tx) 330 mW Peak (Rx) 230 mW Selective Suspend 17 mW
<b>Electrical Interface</b>	USB 2.0 compliant
<b>Bluetooth® Software Supported Link Topology</b>	Microsoft Windows Bluetooth® Software
<b>Power Management</b>	Microsoft Windows ACPI, and USB Bus Support
<b>Certifications</b>	FCC (47 CFR) Part 15C, Section 15.247 & 15.249
<b>Power Management</b>	ETS 300 328, ETS 300 826
<b>Certifications</b>	Low Voltage Directive IEC60950-1/IEC62368-1  UL, CSA, and CE Mark
<b>Bluetooth Profiles Supported</b>	BT4.1-ESR 5/6/7 Compliance LE Link Layer Ping LE Dual Mode LE Link Layer LE Low Duty Cycle Directed Advertising LE L2CAP Connection Oriented Channels Train Nudging & Interlaced Scan BT4.2 ESR08 Compliance LE Secure Connection- Basic/Full LE Privacy 1.2 –Link Layer Privacy LE Privacy 1.2 –Extended Scanner Filter Policies LE Data Packet Length Extension FAX Profile (FAX) Basic Imaging Profile (BIP)2 Headset Profile (HSP) Hands Free Profile (HFP) Advanced Audio Distribution Profile (A2DP)



## Technical Specifications – Input/Output Devices

### I/O DEVICES

<b>HP Business Slim Standalone Wired Keyboard</b>		
<b>Physical Characteristics</b>	Keys	104, 105, 106, 107, 109 layout (depending upon country)
	Dimensions (L x W x H)	171.97 x 68.35 x 8.27 in (436.8± 1.5 x 137.6± 1.0 x 21.0± 1.0 cm)
	Weight	1.32 lb (0.6± 0.08 kg)
<b>Electrical</b>	Operating voltage	4.4-5.25VDC
	Power consumption	50-mA maximum (with 5 VDC power supplied and three LEDs ON)
	System interface	USB or PS/2
	ESD	Contact Discharge: 2, 4,6,8KV Air Discharge: 2, 4, 8,10,12.5KV
	EMI - RFI	Conforms to FCC rules for a Class B computing device
<b>Mechanical</b>	Keycaps	Low-profile design
	Switch actuation	60±12.5g nominal peak force with tactile feedback
	Switch life	10 million keystrokes (Life tester)
	Switch type	Contamination-resistant switch membrane
	Key-leveling mechanisms	For all double-wide and greater-length keys
	Cable length	6 ft (1.8 m)
<b>Environmental</b>	Acoustics	43-dBA maximum sound pressure level
	Operating temperature	50° to 122° F (10° to 50° C)
	Non-operating temperature	Minus 30 degress to 60 degress Celsius
	Operating humidity	10% to 90% (non-condensing at ambient)
	Non-operating humidity	20% to 80% (non-condensing at ambient)
	Operating shock	40 g, six surfaces
	Non-operating shock	80 g, six surfaces
	Operating vibration	2-g peak acceleration
	Non-operating vibration	4-g peak acceleration
	Drop (out of box)	26 in (66 cm) on carpet, six-drop sequence
	Drop (in box)	30 in (76.2 cm) on concrete, 16-drop sequence
<b>Approvals</b>	UL, FCC, CE Mark, TUV GS, VCCI, BSMI, RCM, KCC	
<b>Ergonomic compliance</b>	ANSI HFS 100, ISO 9241-4, and TUVGS	

<b>HP USB Business Slim Wired SmartCard CCID Keyboard</b>		
<b>Physical Characteristics</b>	Keys	104, 105, 109 layout (depending upon country)

## Technical Specifications – Input/Output Devices

	Dimensions (L x W x H)	17.34 x 5.68 x 0.78in (440.6 x 144.5 x 1.98 cm)
	Weight	1.32 lb (598g)
<b>Electrical</b>	Operating voltage	5 VDC, +/-5%
	Power consumption	100mA (All LED on)
	System interface	USB Type A plug connector
	ESD	Contact Discharge: 8 KV Air Discharge: 12.5 KV
	EMI - RFI	Conforms to FCC rules for a Class B computing device
<b>Mechanical</b>	Keycaps	Low-profile design
	Switch actuation	60±10g nominal peak force with tactile feedback
	Switch life	10 million keystrokes (Life tester)
	Switch type	Contamination-resistant switch membrane
	Key-leveling mechanisms	For all double-wide and greater-length keys
	Cable length	6 ft (1.8 m)
<b>Environmental</b>	Acoustics	43-dBA maximum sound pressure level
	Operating temperature	50° to 122° F (10° to 50° C)
	Non-operating temperature	-22° to 140° F (-30° to 60° C)
	Operating humidity	10% to 90% (non-condensing at ambient)
	Non-operating humidity	20% to 80% (non-condensing at ambient)
	Operating shock	40 g, six surfaces
	Non-operating shock	80 g, six surfaces
	Operating vibration	2-g peak acceleration
	Non-operating vibration	4-g peak acceleration
	Drop (out of box)	26 in (66 cm) on carpet, six-drop sequence
	Drop (in box)	30 in (76.2 cm) on concrete, 16-drop sequence
<b>Approvals</b>	CE Marking, TUV, EAC, FCC, cULus/CSAus, ICES, RCM, VCCI, KCC, BSMI	
<b>Ergonomic compliance</b>	ISO 9241-4, TUVGS	

<b>HP USB &amp; PS/2 Washable Standalone Wired Keyboard</b>		
<b>Physical Characteristics</b>	Keys	104, 105 layout (depending upon country)
	Dimensions (L x W x H)	17.68 x 6.68 x 1.22 in (449.18 x 169.66 x 31.2 mm)
	Weight	1.57 lb (710g)
<b>Electrical</b>	Operating voltage	5V +- 5%
	Power consumption	50mA
	System interface	USB Type A plug connector

## Technical Specifications – Input/Output Devices

	ESD	Contact Discharge: 8 KV Air Discharge: 15 KV
	EMI - RFI	Conforms to FCC rules for a Class B computing device
<b>Mechanical</b>	Keycaps	Low-profile design
	Switch actuation	55±10g nominal peak force with tactile feedback
	Switch life	20 million keystrokes (Life tester)
	Switch type	Contamination-resistant switch membrane
	Key-leveling mechanisms	For all double-wide and greater-length keys
	Cable length	ft (2.2 m)
<b>Environmental</b>	Acoustics	43-dBA maximum sound pressure level
	Operating temperature	50° to 122° F (10° to 50° C)
	Non-operating temperature	-4° to 149° F (-20° to 65° C)
	Operating humidity	10% to 95% (non-condensing at ambient)
	Non-operating humidity	0% to 95% (non-condensing at ambient)
	Operating shock	40 g, six surfaces
	Non-operating shock	80 g, six surfaces
	Operating vibration	2-g peak acceleration
	Non-operating vibration	4-g peak acceleration
	Drop (out of box)	26 in (66 cm) on carpet, six-drop sequence
	Drop (in box)	30 in (76.2 cm) on concrete, 16-drop sequence
<b>Approvals</b>	UL, cUL, FCC, CE, TUV GS, VCCI, BSMI, RCM, KCC, USB-IF, WHQL, EN/IEC 60601-1, IP66/NEMA4X	
<b>Ergonomic compliance</b>	ANSI HFS 100, ISO 9241-4, and TUVGS	

### HP USB Wired Keyboard

<b>Physical Characteristics</b>	Keys	104, 105, 106, 108, 109 layouts
	Dimensions (L x W x H)	18.12 x 6.47 x 1.10 in (460.28 x 164.31 x 27.88 mm)
	Weight	1.98 lb (900g) min
<b>Electrical</b>	Operating voltage	5 VDC, +/-5%
	Power consumption	50mA Max (All LED on)
	System interface	USB Type A plug connector
	ESD	Contact Discharge: 8 KV Air Discharge: 15 KV
	EMI - RFI	Conforms to FCC rules for a Class B computing device
<b>Mechanical</b>	Keycaps	Low-profile design
	Switch actuation	60±14g nominal peak force with tactile feedback
	Switch life	20 million keystrokes (Life tester)
	Switch type	Contamination-resistant switch membrane

## Technical Specifications – Input/Output Devices

	Key-leveling mechanisms	For all double-wide and greater-length keys
	Cable length	6 ft (1.8 m)
<b>Environmental</b>	Acoustics	43-dBA maximum sound pressure level
	Operating temperature	50° to 122° F (10° to 50° C)
	Non-operating temperature	-22° to 140° F (-30° to 60° C)
	Operating humidity	10% to 90% (non-condensing at ambient)
	Non-operating humidity	20% to 80% (non-condensing at ambient)
	Operating shock	40 g, six surfaces
	Non-operating shock	80 g, six surfaces
	Operating vibration	2-g peak acceleration
	Non-operating vibration	4-g peak acceleration
	Drop (out of box)	26 in (66 cm) on carpet, six-drop sequence
	Drop (in box)	30 in (76.2 cm) on concrete, 16-drop sequence
<b>Approvals</b>	CUL, FCC, CE Mark, TUV GS, VCCI, BSMI, RCM, KCC, EAC	
<b>Ergonomic compliance</b>	TUVGS	

<b>HP Universal USB Wired Keyboard</b>		
<b>Physical Characteristics</b>	Keys	104, 105 layout (depending upon country)
	Dimensions (L x W x H)	18.15 x 6.02 x 1.08 in (461 x 153 x 27.4 mm)
	Weight	1.32 lb (600g) min
<b>Electrical</b>	Operating voltage	5 VDC, +/-5%
	Power consumption	50mA Max (All LED on)
	System interface	USB Type A plug connector
	ESD	Contact Discharge: 8 KV Air Discharge: 15 KV
	EMI - RFI	Conforms to FCC rules for a Class B computing device
<b>Mechanical</b>	Keycaps	Mid-profile design
	Switch actuation	60±10g nominal peak force with tactile feedback
	Switch life	10 million keystrokes (Life tester)
	Switch type	Contamination-resistant switch membrane
	Key-leveling mechanisms	For all double-wide and greater-length keys
	Cable length	6 ft (1.8 m)
	Microsoft PC 99 - 2001	Mid-profile design
<b>Environmental</b>	Acoustics	43-dBA maximum sound pressure level
	Operating temperature	50° to 122° F (10° to 50° C)
	Non-operating temperature	-22° to 140° F (-30° to 60° C)

## Technical Specifications – Input/Output Devices

	Operating humidity	10% to 90% (non-condensing at ambient)
	Non-operating humidity	20% to 80% (non-condensing at ambient)
	Operating shock	40 g, six surfaces
	Non-operating shock	80 g, six surfaces
	Operating vibration	2-g peak acceleration
	Non-operating vibration	4-g peak acceleration
	Drop (out of box)	26 in (66 cm) on carpet, six-drop sequence
	Drop (in box)	30 in (76.2 cm) on concrete, 16-drop sequence
<b>Approvals</b>	UL, FCC, CE Mark, TUV GS, VCCI, BSMI, RCM, KCC, EAC	
<b>Ergonomic compliance</b>	TUVGS	

### HP Universal USB Wired Mouse

<b>Dimensions (H x L x W)</b>	4.53 x 2.50 x 1.40 in (115 x 63.46 x 35.48 mm)	
<b>Weight</b>	0.18lb (80g)	
<b>Environmental</b>	Operating temperature	50° to 122° F (10° to 50° C)
	Non-operating temperature	-22° to 140° F (-30° to 60° C)
	Operating humidity	10% to 90% (non-condensing at ambient)
	Non-operating humidity	20% to 80% (non-condensing at ambient)
	Operating shock	40 g, six surfaces
	Non-operating shock	80 g, six surfaces
	Operating vibration	2-g peak acceleration
	Non-operating vibration	4-g peak acceleration
<b>Electrical</b>	Operating voltage	5 VDC, +/-5%
	Power consumption (typical)	50mA Max
	Resolution	1,000 DPI
	Sensor	Pixart PAN3606DL
	Tracking speed	30 inch/sec (max)
	Tracking acceleration	9G(max), 1G=9.8m/s <sup>2</sup>
<b>Mechanical</b>	Connector	USB 2.0
	Cable length	6 ft (1.8 m)
	Color	Jack Black
<b>Regulatory approvals</b>	Compliant	UL, FCC, CE Mark, TUV GS, VCCI, BSMI, RCM, KCC, EAC

### HP Optical Mouse

<b>Dimensions (H x L x W)</b>	4.53 x 2.48 x 1.46 in (115.2x 63 x37 mm)	
<b>Weight</b>	0.22lb (101.6g)	
<b>Environmental</b>	Operating temperature	41° to 122° F (5° to 50° C)
	Non-operating temperature	(-4° to 140° F)(-20° to 60° C)

## Technical Specifications – Input/Output Devices

	Operating humidity	10% to 85% (non-condensing at ambient)
	Non-operating humidity	5% to 95% (non-condensing at ambient)
	Operating shock	40 g, six surfaces
	Non-operating shock	80 g, six surfaces
	Operating vibration	2-g peak acceleration
	Non-operating vibration	4-g peak acceleration
<b>Electrical</b>	Tracking speed	30 inch/sec (max)
	Tracking acceleration	8G(max), 1G=9.8m/s <sup>2</sup>
	System interface	USB or PS/2
<b>Mechanical</b>	Switch actuation	60±15g nominal peak force with tactile feedback
	Switch life	3 million keystrokes (Life tester)
	Switch type	Contamination-resistant switch membrane
	Key-leveling mechanisms	For all double-wide and greater-length keys
	Cable length	6 ft (1.8 m)
	Color	Jack Black
<b>Regulatory approvals</b>	Compliant	UL, FCC, CE Mark, TUV GS, VCCI, BSMI, RCM, KCC

### HP USB 1000dpi Laser Mouse

<b>Dimensions (H x L x W)</b>	115 x 62.9 x 37 mm (L x W x H)	
<b>Weight</b>	0.22lb (101.6g)	
<b>Environmental</b>	Operating temperature	50° to 122° F (10° to 50° C)
	Non-operating temperature	-22° to 140° F (-30° to 60° C)
	Operating humidity	10% to 90% (non-condensing at ambient)
	Non-operating humidity	20% to 80% (non-condensing at ambient)
	Operating shock	40 g, six surfaces
	Non-operating shock	80 g, six surfaces
	Operating vibration	2-g peak acceleration
	Non-operating vibration	4-g peak acceleration
<b>Electrical</b>	Operating voltage	5 VDC, +/-5%
	Power consumption (typical)	100mA
	Resolution	1,000 DPI
	Sensor	PixArt vendor Laser USB mouse sensor
	Tracking speed	30 inch/sec (max)
	Tracking acceleration	8G(max), 1G=9.8m/s <sup>2</sup>
<b>Mechanical</b>	Connector	USB 2.0
	Cable length	6 ft (1.8 m)
	Color	Jack Black
<b>Regulatory approvals</b>	Compliant	UL, FCC, CE Mark, TUV GS, VCCI, BSMI, RCM, KCC, EAC

## Technical Specifications – Input/Output Devices

<b>HP USB Fingerprint Mouse</b>		
<b>Dimensions (H x L x W)</b>	107 x 67 x 38.7 mm	
<b>Weight</b>	85 g	
<b>Environmental</b>	Operating temperature	50° to 122° F (10° to 50° C)
	Non-operating temperature	-22° to 140° F (-30° to 60° C)
	Operating humidity	10% to 90% (non-condensing at ambient)
	Non-operating humidity	20% to 80% (non-condensing at ambient)
	Operating shock	40 g, six surfaces
	Non-operating shock	80 g, six surfaces
	Operating vibration	2-g peak acceleration
	Non-operating vibration	4-g peak acceleration
<b>Electrical</b>	Operating voltage	5 VDC, +/-5%
	Power consumption (typical)	130mA
	Resolution	1,200 DPI
	Sensor	PixArt vendor Laser USB mouse sensor
	Tracking speed	30 inch/sec (max)
	Tracking acceleration	8G(max), 1G=9.8m/s <sup>2</sup>
<b>Mechanical</b>	Connector	USB 2.0
	Cable length	6 ft (1.8 m)
	Color	Jack Black
<b>Regulatory approvals</b>	Compliant	UL, FCC, CE Mark, TUV GS, VCCI, BSMI, RCM, KCC, EAC

## Technical Specifications – Audio/Multimedia

### AUDIO/MULTIMEDIA

#### HP ProDesk 400 G6 Desktop Mini PC

<b>Type</b>	Integrated
<b>HD Stereo Codec</b>	Realtek ALC3205
<b>Audio I/O Ports</b>	Front: Headset connector supports a CTIA and OMTP style headset and is retaskable as a Line-in, Line-out, Microphone-in or Headphone-out port
<b>Internal Speaker Amplifier</b>	2W class D mono amplifier for the internal speaker only. External speakers must be powered
<b>Multi-streaming Capable</b>	Playback multi-streaming can be enabled in the audio control panel to allow independent audio streams to be sent to/from the front and rear jacks or integrated speaker.
<b>Sampling</b>	Independent sampling rates for DAC's and ADC's; supports resolutions from 16 to 24-bit; 44.1 kHz to 192 kHz for DAC and 44.1 kHz to 96 kHz for ADC
<b>Wavetable Syntheses</b>	Yes - Uses OS soft wavetable
<b>Analog Audio</b>	Yes
<b># of Channels on Line-Out</b>	Stereo (Left & Right channels)
<b>Internal Speaker</b>	Yes

#### HP ProDesk 400 G7 Small Form Factor PC

<b>Type</b>	Integrated
<b>HD Stereo Codec</b>	Realtek ALC3205
<b>Audio I/O Ports</b>	Front: Headset connector supports a CTIA and OMTP style headset and is retaskable as a Line-in, Line-out, Microphone-in or Headphone-out port Rear: Line-out, port, 3.5mm and support stereo
<b>Internal Speaker Amplifier</b>	2W class D mono amplifier for the internal speaker only. External speakers must be powered
<b>Multi-streaming Capable</b>	Playback multi-streaming can be enabled in the audio control panel to allow independent audio streams to be sent to/from the front and rear jacks or integrated speaker.
<b>Sampling</b>	Independent sampling rates for DAC's and ADC's; supports resolutions from 16 to 24-bit; 44.1 kHz to 192 kHz for DAC and 44.1 kHz to 96 kHz for ADC
<b>Wavetable Syntheses</b>	Yes - Uses OS soft wavetable
<b>Analog Audio</b>	Yes
<b># of Channels on Line-Out</b>	Stereo (Left & Right channels)
<b>Internal Speaker</b>	Yes



## Technical Specifications – Audio/Multimedia

### HP ProDesk 400 G7 Microtower PC

<b>Type</b>	Integrated
<b>HD Stereo Codec</b>	Realtek ALC3205
<b>Audio I/O Ports</b>	Front: Headset connector supports a CTIA and OMTP style headset and is re-taskable as a Line-in, Line-out, Microphone-in or Headphone-out port Rear: Line-out, Line-in*, 3.5mm and support stereo
<b>Internal Speaker Amplifier</b>	2W class D mono amplifier for the internal speaker only. External speakers must be powered
<b>Multi-streaming Capable</b>	Playback multi-streaming can be enabled in the audio control panel to allow independent audio streams to be sent to/from the front and rear jacks or integrated speaker.
<b>Sampling</b>	Independent sampling rates for DAC's and ADC's; supports resolutions from 16 to 24-bit; 44.1 kHz to 192 kHz for DAC and 44.1 kHz to 96 kHz for ADC
<b>Wavetable Syntheses</b>	Yes - Uses OS soft wavetable
<b>Analog Audio</b>	Yes
<b># of Channels on Line-Out</b>	Stereo (Left & Right channels)
<b>Internal Speaker</b>	Yes

**\*NOTE:** Line-in port only available on product with legacy PCI version

### HP ProOne 400 G6 20/24 All-in-One PC

<b>Type</b>	Integrated
<b>HD Stereo Codec</b>	Realtek ALC3252
<b>Audio I/O Ports</b>	Side 3.5mm headset connector supports an OMTP or CTIA style headset and is re-taskable as a Line-in, Line-out, Microphone-in or Headphone-out port
<b>Internal Speaker Amplifier</b>	2W per channel class D stereo amplifier for the internal speakers only
<b>Multi-streaming Capable</b>	Playback multi-streaming allows independent audio streams to be sent to/from the side jack and integrated speakers.
<b>Sampling</b>	Independent sampling rates for DAC's and ADC's; supports resolutions from 16 to 24-bit; 44.1 kHz to 192 kHz for DAC and 44.1 kHz to 96 kHz for ADC
<b>Wavetable Syntheses</b>	Yes – Uses OS Soft Wavetable
<b>Analog Audio</b>	Yes
<b># of Channels on Line-Out</b>	Stereo (Left & Right channels)
<b>Internal Speaker</b>	Yes - Stereo

### INTEGRATED WEBCAM AND MICROPHONE

Optional integrated 1 MP HD RGB webcam & microphone; maximum resolution of 1280 x 720

Optional integrated 5 MP RGB webcam & microphone; maximum resolution of 2592 x 1944

Optional integrated 5 MP RGB webcam with IR sensor & microphone; maximum resolution of 2592 x 1944

## Technical Specifications – Power

### POWER

	<u>DM</u>	<u>SFF</u>	<u>MT</u>	<u>AIO</u>
<b>External Power Supplies</b>	65W EPS, 88% average efficiency at 115V & 89% at 230Vac	N/A	N/A	90W EPS, active PFC, 88% efficiency in 115Vac / 89% efficiency in 230Vac 120W EPS, active PFC, 88% efficiency in 115Vac / 89% efficiency in 230Vac 150W EPS, active PFC, 88% efficiency in 115Vac / 89% efficiency in 230Vac
<b>80 PLUS Gold</b>	N/A	180W active PFC / 80 PLUS Gold 87/90/87% efficient at 20/50/100% load (115V) 90/92/89% efficient at 20/50/100% load (230V)	180W active PFC / 80 PLUS Gold 87/90/87% efficient at 20/50/100% load (115V) 90/92/89% efficient at 20/50/100% load (230V)	N/A
<b>80 PLUS Platinum</b>	N/A	210W active PFC / 80 PLUS Platinum 90/92/89% efficient at 20/50/100% load (115V) 91/93/90% efficient at 20/50/100% load (230V)	260W active PFC / 80 PLUS Platinum 350W active PFC / 80 PLUS Platinum 90/92/89% efficient at 20/50/100% load (115V) 91/93/90% efficient at 20/50/100% load (230V)	N/A
<b>Operating Voltage Range</b>	90Vac~264Vac	90Vac~264Vac	90Vac~264Vac	90Vac~264Vac
<b>Rated Voltage Range</b>	100Vac~240Vac	100Vac~240Vac	100Vac~240Vac	100Vac~240Vac
<b>Rated Line Frequency</b>	50HZ~60HZ	50HZ~60HZ	50HZ~60HZ	50HZ~60HZ
<b>Operating Line Frequency</b>	47HZ~63HZ	47HZ~63HZ	47HZ~63HZ	47HZ~63HZ
<b>Rated Input Current with Energy Efficient* Power Supply</b>	65W ≤ 1.7A 90W ≤ 1.2A	180W Gold ≤ 2.3A 210W Platinum ≤ 2.5A	180W ≤ 2.3A 260W ≤ 3.1A 350W ≤ 4A 550W ≤ 6.6A	90W ≤ 1.7A 120W ≤ 2.2A 150W ≤ 2.5A
<b>DC Output</b>	+19.5V	+12V	+12V	+19.5V
<b>Current Leakage (NFPA 99: 2102)</b>	Less than 500 microamps of leakage current at 264 Vac with the ground wire disconnected, as required for Non-patient Electrical Appliances and Equipment used in a patient care facility or	Less than 500 microamps of leakage current at 264 Vac with the ground wire disconnected, as required for Non-patient Electrical Appliances and	Less than 500 microamps of leakage current at 264 Vac with the ground wire disconnected, as required for Non-patient Electrical Appliances and	Less than 500 microamps of leakage current at 264 Vac with the ground wire disconnected, as required for Non-patient Electrical Appliances and

## Technical Specifications – Power

	that contact patients in normal use. Per section 10.3.5.1. Less than 100 microamps of leakage current at 264 Vac with the ground wire intact with normal polarity, as required for Non-patient Electrical Appliances and Equipment used in a patient care facility or that contact patients in normal use. Per section 10.3.5.1.	Equipment used in a patient care facility or that contact patients in normal use. Per section 10.3.5.1. Less than 100 microamps of leakage current at 264 Vac with the ground wire intact with normal polarity, as required for Non-patient Electrical Appliances and Equipment used in a patient care facility or that contact patients in normal use. Per section 10.3.5.1.	Equipment used in a patient care facility or that contact patients in normal use. Per section 10.3.5.1. Less than 100 microamps of leakage current at 264 Vac with the ground wire intact with normal polarity, as required for Non-patient Electrical Appliances and Equipment used in a patient care facility or that contact patients in normal use. Per section 10.3.5.1.	Equipment used in a patient care facility or that contact patients in normal use. Per section 10.3.5.1. Less than 100 microamps of leakage current at 264 Vac with the ground wire intact with normal polarity, as required for Non-patient Electrical Appliances and Equipment used in a patient care facility or that contact patients in normal use. Per section 10.3.5.1.
<b>Power Supply Fan</b>	N/A	50mm variable speed	70mm variable speed	N/A
<b>Power cord length</b>	6.0 ft. (1.83 m)	6.0 ft. (1.83 m)	6.0 ft. (1.83 m)	6.0 ft. (1.83 m)
<b>Dimensions</b>	65W: 102 x 55 x 30 mm 90W: 127 x 50 x 30 mm / 132 x 57 x 30 mm	200 x 85 x 53 mm	165 x 95 x 73 mm	90W: 127 x 50 x 30 mm / 132 x 57 x 30 mm 120W: 148 x 75.5 x 25.4 mm 150W: 160 x 80 x 40 mm

The power supply shall comply with harmonic input current requirements as detailed in EN61000-3-2 and JEIDA MITI standards. The harmonic input current requirements must be met under the following operating conditions:

Load Requirements: 50% and 100%

Input Voltage: 230Vac/50Hz.

For active power factor correction the power factor at 50% & 100% loads shall be greater than 0.9 over the entire nominal input voltage range (100-127VAC and 200-240VAC).

Condition	Standard Efficiency	82/85/82%	85/88/85%	87/90/87%	90/92/89%	Input Voltage
10% of Rated Load	-	75%	81%	84%	86%	115Vac/60HZ
20% of Rated Load	-	82%	85%	87%	90%	115Vac/60HZ
50% of Rated Load	-	85%	88%	90%	92%	115Vac/60HZ
	PF>0.9	PF>0.9	PF>0.9	PF>0.9	PF>0.95	
100% of Rated Load	70%	82%	85%	87%	89%	115Vac/60HZ
	PF>0.9	PF>0.9	PF>0.9	PF>0.9	PF>0.9	230Vac/50HZ

## Technical Specifications – Weights and Dimensions

### WEIGHTS & DIMENSIONS<sup>1</sup>

	<b>DM</b>	<b>SFF</b>	<b>MT</b>
<b>Chassis (W x D x H)</b>	6.97 x 6.89 x 1.35 in 177 x 175 x 34.2 mm	10.6 x 11.9 x 3.7 in 270 x 303 x 95 mm	6.1 x 13.27 x 11.93 in 155x 337 x 303 mm
<b>System Volume</b>	64 cu in 1.05 L	474 cu in 7.8 L	965 cu in 15.83 L
<b>System Weight<sup>1</sup></b>	2.74 lbs 1.25 kg	8.6 lbs 3.9 kg	11.01 lbs 5 kg
<b>Max Supported Weight (desktop orientation)</b>	N/A	77 lbs 35 kg	77 lbs 35 kg
<b>Packaging Dimension (W x D x H)</b>	19.57 x 5.04 x 8.78 in (497 x 128 x 223 mm) <b>MPP:</b> 19.61 x 9.25 x 5.20 in (498 x 235 x 132 mm)	15.52 x 8.07 x 19.65 in (394 x 205 x 499 mm) <b>MPP:</b> 15.52 x 8.07 x 19.65 in (394 x 205 x 499 mm)	15.75 x 11.30 x 19.65 in (400 x 287 x 499 mm) <b>MPP:</b> 15.75 x 11.30 x 19.65 in (400 x 287 x 499 mm)
<b>Shipping Weight</b>	6.52 lbs (2.97 kg) <b>MPP:</b> 7.50 lbs (3.40 kg)	15.37 lbs (6.97 kg) <b>MPP:</b> 15.86 lbs (7.2 kg)	16.85 lbs (7.65 kg) <b>MPP:</b> 17.55 lbs (7.97 kg)
<b>Palletization Profile</b>	18-units per layer 5 or 6 layers max depending on details of air freight 90 or 108 units per pallet depending on details of air freight 45.354 x 39.13 x 57.80 in, 1152 x 994 x 1468 mm (include pallet)	6-units per layer 11 layer max 66 per pallet 47.24 x 39.37 x 93.90 in, 1200 x 1000 x 2380 mm (including pallet)	6-units per layer 8 layer max 48 per pallet 47.24 x 39.37 x 95.12 in, 1200 x 1000 x 2416 mm (including pallet)
<b>Palletization Profile (Molded Pulp)</b>	10-units per layer 10 to 19 layers max depending on details of freight 100 or 190 units per pallet depending on details of freight 46.26 x 39.21 x 103.74 in, 1175 x 996 x 2635 mm (including pallet)	6-units per layer 11 layer max 66 per pallet 47.24 x 39.37 x 93.90 in, 1200 x 1000 x 2380 mm (including pallet)	6-units per layer 8 layer max 48 per pallet 47.24 x 39.37 x 95.12 in, 1200 x 1000 x 2416 mm (including pallet)

1. Packaging material used will vary by country

2. Configured with 1 HDD & 1 ODD; DM configured with 1 HDD only

## Technical Specifications – Weights and Dimensions

### ALL-IN-ONE DIMENSIONS<sup>1</sup>

#### HP ProOne 400 G6 24 All-in-One PC

		Without Stand		Cantilever Stand (Fixed Height Tilt Stand)		Adjustable Height Stand	
		cm/kg	inch/lbs	cm/kg	inch/lbs	cm/kg	inch/lbs
<b>Product</b>	<b>Width</b>	53.93 cm	21.23 in	53.93 cm	21.23 in	53.93 cm	21.23 in
	<b>Length/Depth</b>	5.07 cm	2.0 in	15.65 cm	6.16 in	23.3 cm	9.17 in
	<b>Height</b>	35.32 cm	13.91 in	40.32 cm	15.87 in	38.2 ~ 51.1 cm	15.04 ~ 20.12 in
	<b>Weight</b>	5.858 kg	12.91 lbs	6.588 kg	14.52 lbs	7.748 kg	17.08 lbs
<b>Package</b>	<b>Width</b>	66.0 cm	25.98 in	66.0 cm	25.98 in	66.0 cm	25.98 in
	<b>Length/Depth</b>	24.5 cm	9.65 in	24.5 cm	9.65 in	24.5 cm	9.65 in
	<b>Height</b>	46.2 cm	18.19 in	46.2 cm	18.19 in	46.2 cm	18.19 in
	<b>Weight</b>	9.69 kg	21.36 lbs	10.42 kg	22.97 lbs	11.58 kg	25.53 lbs
<b>Palletization for Sea/Rail</b>	<b>Width</b>	120.0 cm	47.24 in	120.0 cm	47.24 in	120.0 cm	47.24 in
	<b>Length/Depth</b>	100.0 cm	39.37 in	100.0 cm	39.37 in	100.0 cm	39.37 in
	<b>Height</b>	198.8 cm	78.27 in	198.8 cm	78.27 in	198.8 cm	78.27 in
	<b>Weight</b>	249.64 kg	550.4 lbs	267.16 kg	589.04 kg	295 kg	650.48 lbs
	<b>Qty / Layer Layers</b>		6 4		6 4		6 4
<b>Qty / Pallet via Sea/Rail</b>		24		24		24	
<b>Qty / Pallet via Air</b>		18		18		18	

1. Packaging material used will vary by country

2. Configured with 1 HDD & 1 ODD

#### HP ProOne 400 G6 20 All-in-One PC

		Without Stand		Cantilever Stand (Fixed Height Tilt Stand)		Adjustable Height Stand	
		cm/kg	inch/lbs	cm/kg	inch/lbs	cm/kg	inch/lbs
<b>Product</b>	<b>Width</b>	47.2 cm	18.58 in	47.2 cm	18.58 in	47.2 cm	18.58 in
	<b>Length/Depth</b>	5.07 cm	2.0 in	15.65 cm	6.16 in	20.15 cm	7.93 in
	<b>Height</b>	31.6 cm	12.44 in	36.61 cm	14.41 in	34.4 ~ 47.43 cm	13.54 ~ 18.67 in
	<b>Weight</b>	4.74 kg	10.45 lbs	5.46 kg	12.04 lbs	6.32 kg	13.93 lbs
<b>Package</b>	<b>Width</b>	59.5 cm	23.43 in	59.5 cm	23.43 in	59.5 cm	23.43 in
	<b>Length/Depth</b>	24.5 cm	9.65 in	24.5 cm	9.65 in	24.5 cm	9.65 in
	<b>Height</b>	41.4 cm	16.30 in	41.4 cm	16.30 in	41.4 cm	16.30 in
	<b>Weight</b>	7.44 kg	16.41 lbs	8.16 kg	18.0 lbs	9.02 kg	19.89 lbs
<b>Palletization for Sea/Rail</b>	<b>Width</b>	120 cm	47.24 in	120 cm	47.24 in	120 cm	47.24 in
	<b>Length/Depth</b>	100 cm	39.37 in	100 cm	39.37 in	100 cm	39.37 in
	<b>Height</b>	221 cm	87.07 in	221 cm	87.07 in	221 cm	87.07 in
	<b>Weight</b>	311.8 kg	697.68 lbs	340.6 kg	761.28 lbs	375 kg	826.88 lbs
	<b>Qty / Layer Layers</b>		8 5		8 5		8 5
<b>Qty / Pallet via Sea/Rail</b>		40		40		40	
<b>Qty / Pallet via Air</b>		24		24		24	

1. Packaging material used will vary by country

2. Configured with 1 HDD & 1 ODD



## Miscellaneous Features

### MISCELLANEOUS FEATURES

#### Management Features

- Advanced Configuration and Power Management Interface (ACPI). Allows the system to wake from a low power mode. Controls system power consumption, making it possible to place individual cards and peripherals in a low-power or powered-off state without affecting other elements of the system.
- Intel® Wired for Management support; industry wide initiative to make Intel® architecture based PCs, servers and mobile computers more inherently manageable out-of-the-box and over the network
- Dual State Power Button; acts as both an on/off button and a suspend-to-sleep button

#### Serviceability Features

- Dual colored power LED on front of computer to indicate either normal or fault condition
- Diagnostic LED Explanation Table:
  - Power LED will blink red 2 to 5 times, then blink white 2 or more times, then repeat (with beep tones for each blink initially):
    - 2 red + 2 white User must provide file for BIOS recovery (USB storage typically)
    - 2 red + 3 white User must enter a key sequence to proceed with recovery by policy
    - 2 red + 4 white BIOS recovery is in progress
    - 3 red + 2 white Memory could not be initialized
    - 3 red + 3 white Graphics adaptor could not be found
    - 3 red + 4 white Power supply failure / not connected
    - 3 red + 5 white Processor not installed
    - 3 red + 6 white Current processor does not support an enabled feature
    - 4 red + 2 white Processor has exceeded its temperature threshold / system thermal shutdown
    - 4 red + 3 white System internal temperature has exceeded its threshold
    - 5 red + 2 white System controller firmware is not valid
    - 5 red + 3 white System controller detected BIOS is not executing
    - 5 red + 4 white BIOS could not complete initialization / mainboard failure
    - 5 red + 5 white System controller rebooted the system after a health or recovery timer triggered
- HP PC Hardware Diagnostics UEFI:
  - This utility enables hardware level testing outside the operating system on many components. The diagnostics can be invoked by pressing F2 at POST, and is available as a download from HP Support
- System/Emergency ROM
- Flash ROM
- CMOS Battery Holder for easy replacement
- Flash Recovery with Video Configuration Record Software5
- 5 Aux Power LED on System mainboard
- Processor ZIF Socket for easy Upgrade
- Over-Temp Warning on Screen (Requires IM Agents)
- DIMM Connectors for easy Upgrade
- Clear CMOS Button
- NIC LEDs (integrated) (Green & Amber)
- Dual Color Power and HD LED - To Indicate Normal Operations and Fault Conditions
- Color coordinated cables and connectors
- Tool-less Hood Removal
- Front power switch
- System memory can be upgraded without removing the system board or any internal components
- Tool-less Hard Drive, memory & optical drive Removal (For MT, SFF, and DM only)
- Green Pull Tabs, and Quick Release Latches for easy Identification

## Miscellaneous Features

### Additional Features

#### Product Orientation

#### Description

Microtower (MT) can be oriented in a tower (vertical) orientation.  
Small Form Factor (SFF) can be oriented as either a desktop (horizontal) or a tower (vertical) with optional vertical stand.  
Desktop Mini (DM) can be oriented as either a desktop (horizontal) or a tower (vertical) with optional vertical stand.

#### Boot Sectors Protection

MBR and GPT sectors of the hard drive are critical to booting the operating system. By saving the MBR or GPT data (depending on the how the OS was installed), the BIOS will be able to monitor for changes and allow the user to override them with the backup copy at boot-up.

#### Drive Protection System

#### DPS Access through F10 Setup during Boot

A diagnostic hard drive self- test. It scans critical physical components and every sector of the hard drive for physical faults and then reports any faults to the user

Running independently of the operating system, it can be accessed through a Windows-based diagnostics utility or through the computer's setup procedure. It produces an evaluation on whether the hard drive is the source of the problem and needs to be replaced

The system expands on the Self-Monitoring, Analysis, and Reporting Technology (SMART), a continuously running systems diagnostic that alerts the user to certain types of failures

#### SMART Technology (Self-Monitoring, Analysis and Reporting Technology)

Allows hard drives to monitor their own health and to raise flags if imminent failures were predicted

#### SMART I - Drive Failure Prediction

Predicts failures before they occur. Tracks fault prediction and failure indication parameters such as re-allocated sector count, spin retry count, calibration retry count

#### SMART II - Off-Line Data Collection

By avoiding actual hard drive failures, SMART hard drives act as "insurance" against unplanned user downtime and potential data loss from hard drive failure

#### SMART III - Off-Line Read Scanning with Defect Reallocation

IOEDC: I/O Error Detection Circuitry

#### SMART IV - End-to-End CRC for hard drives

Detects errors in Read/Write buffers on HDD cache RAM

## After Market Options

### AFTER MARKET OPTIONS

<b>Graphics Solutions</b>	<b><u>DM</u></b>	<b><u>SFF</u></b>	<b><u>MT</u></b>	<b><u>AiO</u></b>	<b><u>Part Number</u></b>
AMD Radeon RX 550X 4GB DP Display Card		X	X		5LH79AA
AMD Radeon R7 430 2GB 2 Display Port Card		X	X		5JW82AA
AMD Radeon R7 430 2GB DP+VGA Card		X	X		5JW81AA
HP DisplayPort™ To HDMI True 4k Adapter	X	X	X	X	2JA63AA
HP DVI Cable Kit		X	X		DC198A
HP HDMI Standard Cable Kit	X	X	X	X	T6F94AA
HP DisplayPort™ Cable Kit	X	X	X	X	VN567AA
HP DisplayPort™ To VGA Adapter	X	X	X	X	AS615AA
HP DisplayPort™ To DVI-D Adapter	X	X	X	X	FH973AA

<b>Desktop Mini Accessories</b>	<b><u>DM</u></b>	<b><u>SFF</u></b>	<b><u>MT</u></b>	<b><u>AiO</u></b>	<b><u>Part Number</u></b>
HP Desktop Mini Port Cover v2	X				13L69AA
HP Desktop Mini 2.5" SATA Drive Bay kit v2	X				13L70AA
HP Desktop Mini LockBox V2	X				3EJ57AA
HP Desktop Mini DVD-Writer ODD Expansion Module	X (Either one)				K9Q83AA
HP Desktop Mini I/O Expansion Module					K9Q84AA
HP Desktop Mini Security/Dual VESA Sleeve v3	X				13L67AA
HP Desktop Mini Security/Dual VESA Sleeve v3 With Power Supply Holder	X				13L68AA
HP B300 PC Mounting Bracket with Power Supply Holder	X				7DB37AA
HP Desktop Mini Vertical Chassis Stand	X				G1K23AA
HP DM Power Supply Holder Kit v2	X				7DB38AA

<b>Data Storage Drives</b>	<b><u>DM</u></b>	<b><u>SFF</u></b>	<b><u>MT</u></b>	<b><u>AiO</u></b>	<b><u>Part Number</u></b>
HP PCIe NVME TLC 256GB SSD M.2 Drive	X	X	X	X	1CA51AA
HP PCIe NVME TLC 512GB SSD M.2 Drive	X	X	X	X	X8U75AA
HP 500GB 7200PRM SATA 6.0Gb/s 3.5" Hard Drive		X	X		QK554AA
HP 1TB 7200rpm SATA 6Gb/s 3.5" Hard Drive		X	X		QK555AA
HP 9.5mm G3 8/6/4 SFF G4 400 SFF/MT DVD Writer		X	X		1CA53AA
HP Prodesk 400/600 MT 2 <sup>nd</sup> 3.5" HDD cage			X		13L71AA



# QuickSpecs

HP ProDesk 400 G6 DM / AIO – G7 MT / SFF

## After Market Options

<b>Input Devices</b>	<b>DM</b>	<b>SFF</b>	<b>MT</b>	<b>AiO</b>	<b>Part Number</b>
HP Wired Desktop 320K Keyboard	X	X	X	X	9SR37AA
HP USB Business Slim CCID SmartCard Keyboard	X	X	X	X	Z9H48AA
HP PS/2 Business Slim Keyboard		X	X		N3R86AA
HP Wired Desktop 320MK Mouse and Keyboard	X	X	X	X	9SR36AA
HP USB Antimicrobial Business Slim Keyboard and Mouse	X	X	X	X	Z9H50AA
HP USB Keyboard	X	X	X	X	QY776AA
HP USB PS/2 Washable Keyboard & Mouse	X	X	X	X	BU207AA
HP Wireless Business Slim Keyboard and Mouse	X	X	X	X	N3R88AA
HP Wired Desktop 320M Mouse	X	X	X	X	9VA80AA
HP USB Grey v2 Mouse	X	X	X	X	Z9H74AA
HP PS/2 Mouse		X	X		QY775AA
HP USB Fingerprint Mouse	X	X	X	X	4TS44AA
HP USB 1000dpi Laser Mouse	X	X	X	X	QY778AA
HP USB Optical Mouse	X	X	X	X	QY777AA

<b>Intel® Optane™ Memory</b>	<b>DM</b>	<b>SFF</b>	<b>MT</b>	<b>AiO</b>	<b>Part Number</b>
Intel® Optane Memory 16GB (Cache)	X	X	X	X	1WV97AA
512GB Intel® Optane™ Memory H10 with SSD	X	X	X	X	6VF55AA

<b>System Memory</b>	<b>DM</b>	<b>SFF</b>	<b>MT</b>	<b>AiO</b>	<b>Part Number</b>
HP 4GB DDR4-2666 UDIMM		X	X		3TK85AA
HP 8GB DDR4-2666 UDIMM		X	X		3TK87AA
HP 16GB DDR4-2666 UDIMM		X	X		3TK83AA
HP 32GB DDR4-2666 UDIMM		X	X		1C918AA
HP 4GB DDR4-2666 SODIMM	X			X	3TK86AA
HP 8GB DDR4-2666 SODIMM	X			X	3TK88AA
HP 16GB DDR4-2666 SODIMM	X			X	3TK84AA
HP 4GB DDR4-3200 UDIMM		X	X		13L78AA
HP 8GB DDR4-3200 UDIMM		X	X		13L76AA
HP 16GB DDR4-3200 UDIMM		X	X		13L74AA
HP 32GB DDR4-3200 UDIMM		X	X		13L72AA
HP 4GB DDR4-3200 SODIMM	X			X	13L79AA
HP 8GB DDR4-3200 SODIMM	X			X	13L77AA
HP 16GB DDR4-3200 SODIMM	X			X	13L75AA
HP 32GB DDR4-3200 SODIMM	X			X	13L73AA

<b>Multimedia Devices</b>	<b>DM</b>	<b>SFF</b>	<b>MT</b>	<b>AiO</b>	<b>Part Number</b>
HP Business Headset v2	X	X	X	X	T4E61AA



## After Market Options

HP S101 Speaker Bar	X	X	X		5UU40AA
HP UC Speaker Phone v2	X	X	X		4VW02AA

<b>Communication Devices</b>	<b>DM</b>	<b>SFF</b>	<b>MT</b>	<b>AiO</b>	<b>Part Number</b>
Intel® Ethernet I210-T1 GbE NIC		X	X		E0X95AA

<b>Security Devices</b>	<b>DM</b>	<b>SFF</b>	<b>MT</b>	<b>AiO</b>	<b>Part Number</b>
HP Business PC Security Lock v3 Kit		X	X	X	3XJ17AA
HP Dual Head Keyed Cable Lock	X	X	X	X	T1A64AA
HP Keyed Cable Lock 10mm	X	X	X	X	T1A62AA
HP Master Keyed Cable Lock 10mm	X	X	X	X	T1A63AA

<b>Stands and Mounting Accessories</b>	<b>DM</b>	<b>SFF</b>	<b>MT</b>	<b>AiO</b>	<b>Part Number</b>
HP B250 PC Mounting Bracket	X				8RA46AA
HP B300 PC Mounting Bracket	X				2DW53AA
HP B500 PC Mounting Bracket	X				2DW52AA
HP Quick Release Bracket 2	X			X	6KD15AA
HP Single Monitor Arm				X	BT861AA
HP ProOne G6 VESA Plate with Power Supply Holder				X	13L66AA
HP ProOne G6 Height Adjustable Stand				X	13L65AA

<b>I/O Devices</b>	<b>DM</b>	<b>SFF</b>	<b>MT</b>	<b>AiO</b>	<b>Part Number</b>
HP DisplayPort Port Flex IO v2	X	X	X		13L54AA
HP HDMI Port Flex IO v2	X	X	X		13L55AA
HP Type-C USB 3.1 Gen2 Port Flex IO v2		X	X		13L59AA
HP Type-C USB 3.1 Gen2 Port with 100W PD Flex IO v2	X				13L60AA
HP VGA Port Flex IO v2	X	X	X		13L53AA
HP Serial Port Flex IO v2	X	X	X		13L56AA
HP Serial Port Flex IO 2nd	X				13L57AA
HP Internal Serial Port (400)			X		3TK81AA
HP PCIe x1 Parallel Port Card		X	X		N1M40AA
HP 800/600/400 G3 Serial/ PS/2 Adapter		X	X		1VD82AA

**NOTE:** For more detail on HP I/O Devices please refer to the [HP FLEX IO Option Cards QuickSpecs](http://h20195.www2.hp.com/v2/GetDocument.aspx?docname=c06042607). URL is: <http://h20195.www2.hp.com/v2/GetDocument.aspx?docname=c06042607>

© Copyright 2020 HP Development Company, L.P. All rights reserved.

The information contained herein is subject to change without notice. The only warranties for HP products are set forth in the express limited warranty statements accompanying such products. Nothing herein should be construed as constituting an additional warranty. HP shall not be liable for technical or editorial errors or omissions contained herein. Microsoft and Windows are registered trademarks or trademarks of Microsoft Corporation in the U.S. and/or other countries. Intel, Celeron, Core, Pentium are registered trademarks or trademarks of Intel Corporation in the U.S. and/or other countries. Bluetooth® is a trademark of its proprietor, used by HP, Inc. under license. USB Type-C™ and USB-C™ are trademarks of USB Implementers Forum. NVIDIA, GeForce and NVS are trademarks and/or registered trademarks of NVIDIA Corporation in the U.S. and other countries. AMD and Radeon are trademarks of Advanced Micro Devices, Inc. ENERGY STAR is a registered trademark owned by the U.S. Environmental Protection Agency. DisplayPort™ and the DisplayPort™ logo are trademarks owned by the Video Electronics Standards Association (VESA®) in the United States and other countries.

